

15-213

“The course that gives CMU its Zip!”

Machine-Level Programming III: Procedures Sept. 17, 2002

Topics

- IA32 stack discipline
- Register saving conventions
- Creating pointers to local variables

IA32 Stack

- Region of memory managed with stack discipline
- Grows toward lower addresses
- Register `%esp` indicates lowest stack address
 - address of top element

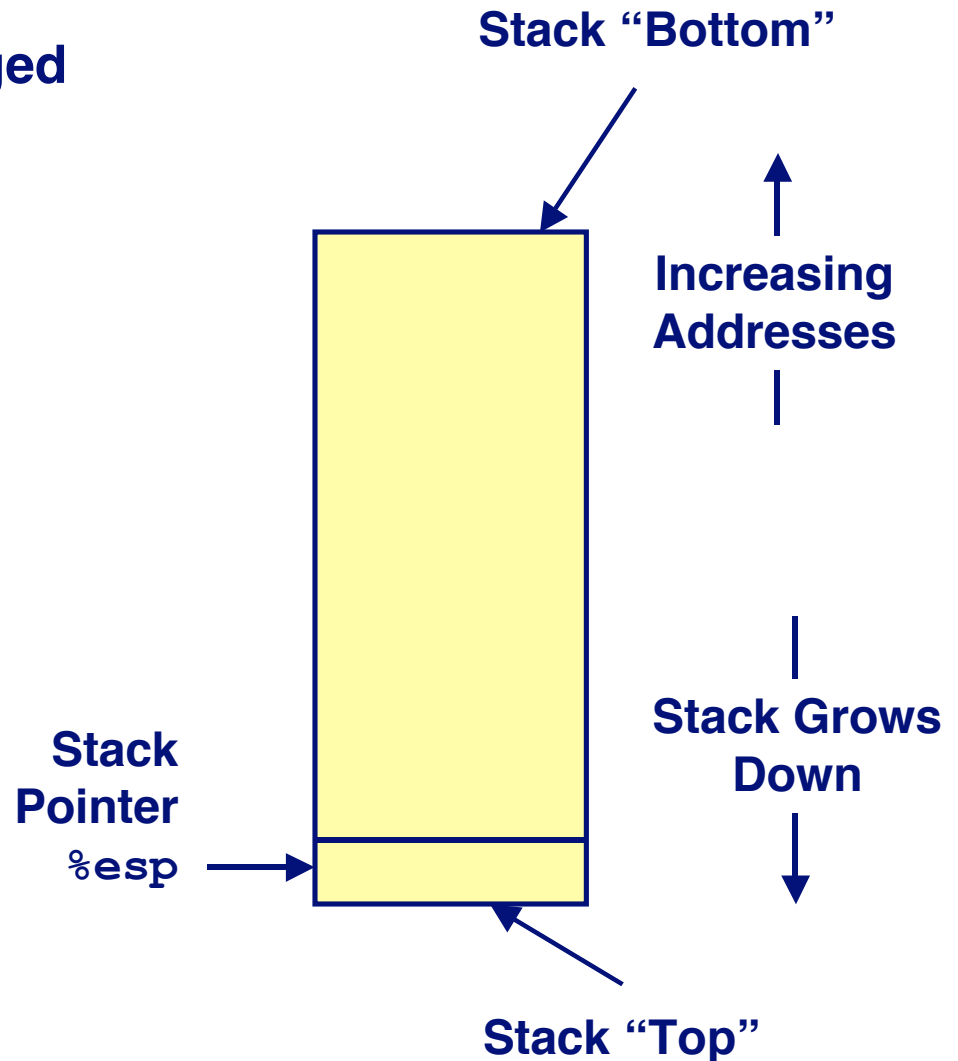

IA32 Stack Pushing

Pushing

- `pushl Src`
- Fetch operand at `Src`
- Decrement `%esp` by 4
- Write operand at address given by `%esp`

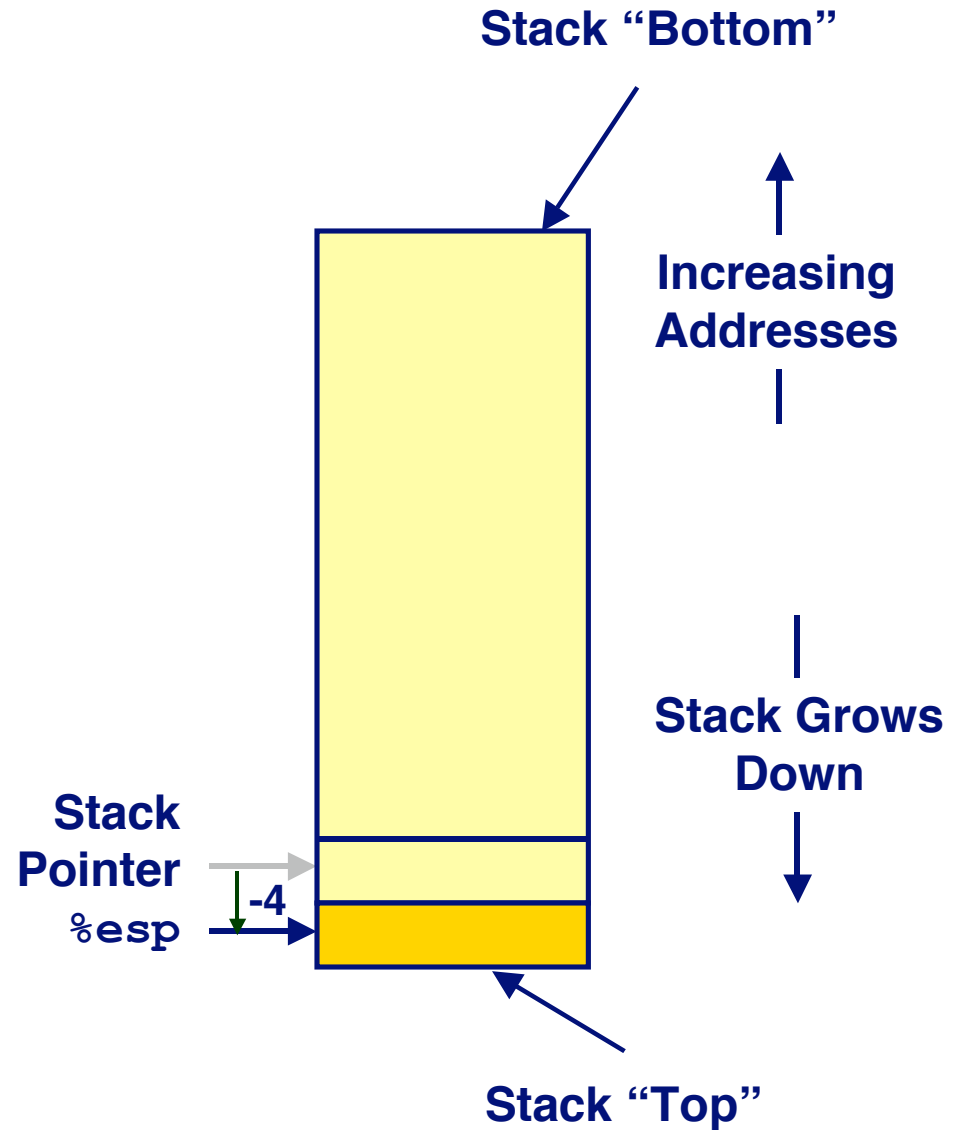

IA32 Stack Popping

Popping

- `popl Dest`
- Read operand at address given by `%esp`
- Increment `%esp` by 4
- Write to `Dest`

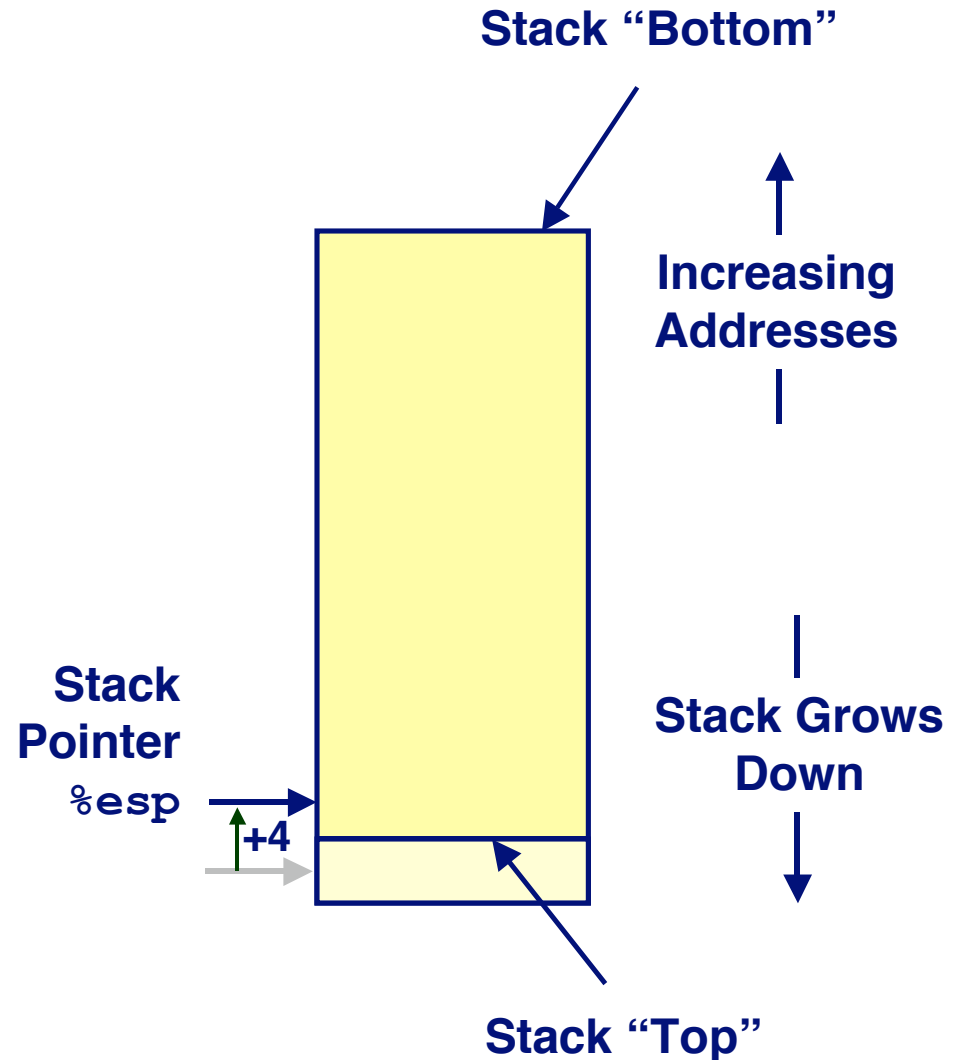

Stack Operation Examples

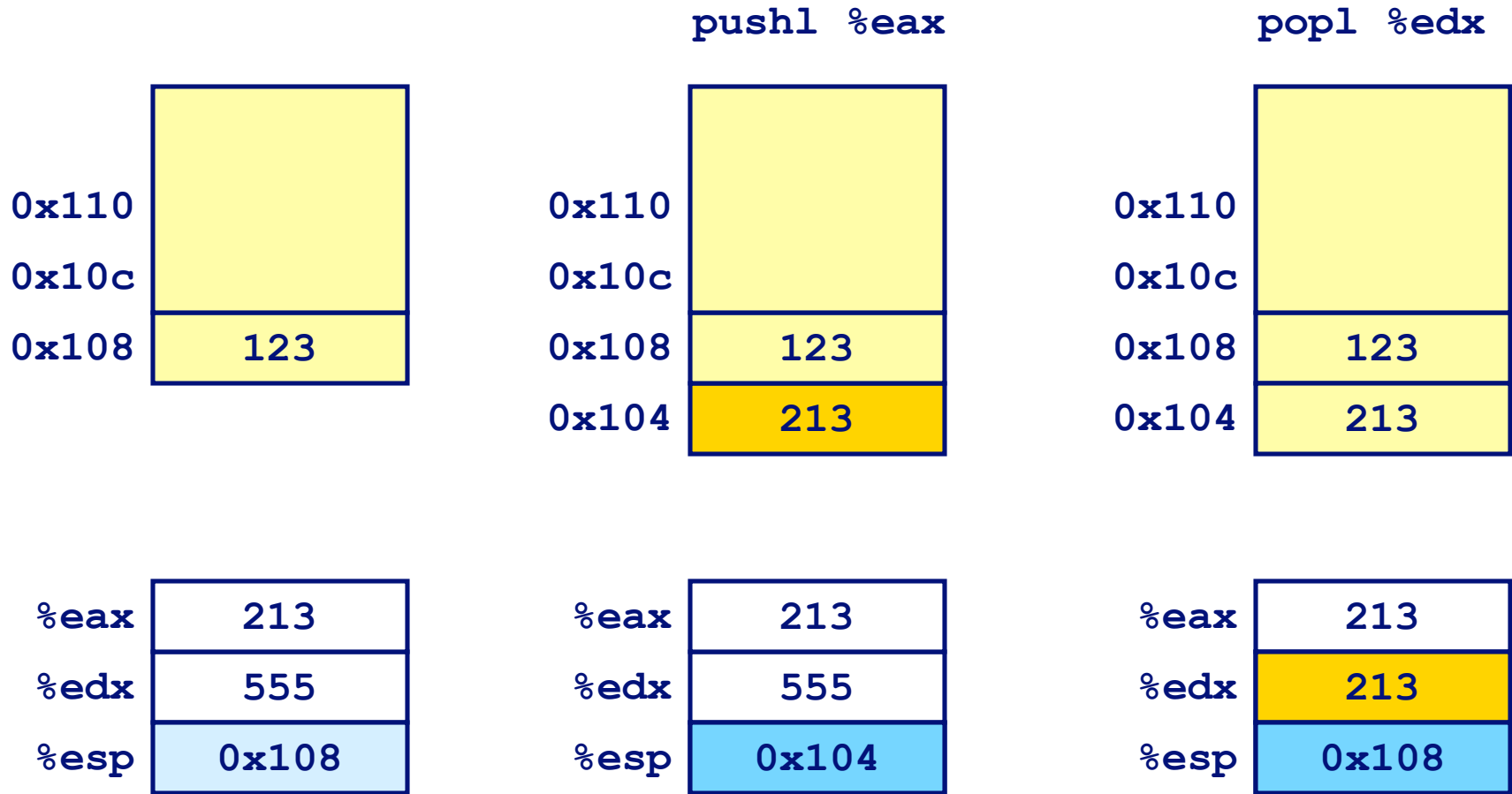

Procedure Control Flow

- Use stack to support procedure call and return

Procedure call:

`call label` Push return address on stack; Jump to `label`

Return address value

- Address of instruction beyond `call`
- Example from disassembly

```
804854e: e8 3d 06 00 00    call    8048b90 <main>
8048553: 50                pushl  %eax
```

- Return address = 0x8048553

Procedure return:

- `ret` Pop address from stack; Jump to address

Procedure Call Example

```
804854e: e8 3d 06 00 00    call 8048b90 <main>
8048553: 50                pushl %eax
```

```
call 8048b90
```

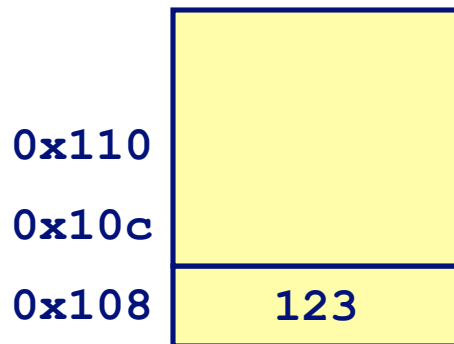

`%esp` 0x108

`%eip` 0x804854e

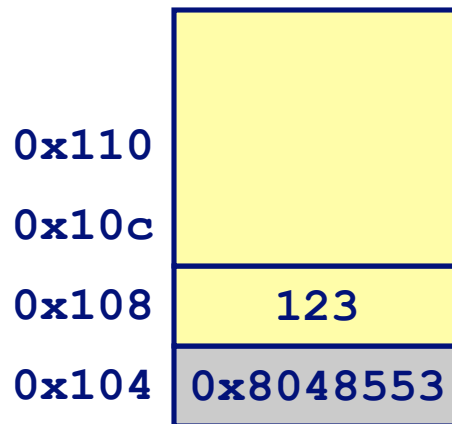

`%esp` 0x104

`%eip` 0x8048b90

`%eip` is program counter

Procedure Return Example

8048591: c3

ret

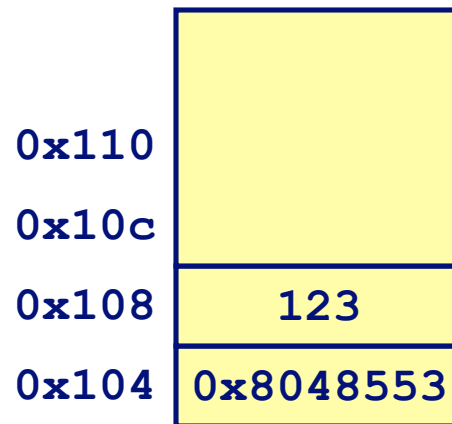

%esp 0x104

%eip 0x8048591

ret

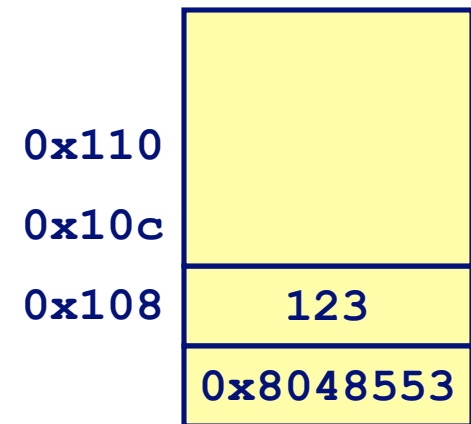

%esp 0x108

%eip 0x8048553

%eip is program counter

Stack-Based Languages

Languages that Support Recursion

- e.g., C, Pascal, Java
- Code must be “*Reentrant*”
 - Multiple simultaneous instantiations of single procedure
- Need some place to store state of each instantiation
 - Arguments
 - Local variables
 - Return pointer

Stack Discipline

- State for given procedure needed for limited time
 - From when called to when return
- Callee returns before caller does

Stack Allocated in *Frames*

- state for single procedure instantiation

Call Chain Example

Code Structure

```
yoo (...)  
{  
  .  
  .  
  who ();  
  .  
  .  
}
```

```
who (...)  
{  
  . . .  
  amI ();  
  . . .  
  amI ();  
  . . .  
}
```

```
amI (...)  
{  
  .  
  .  
  amI ();  
  .  
  .  
}
```

- Procedure amI recursive

Call Chain

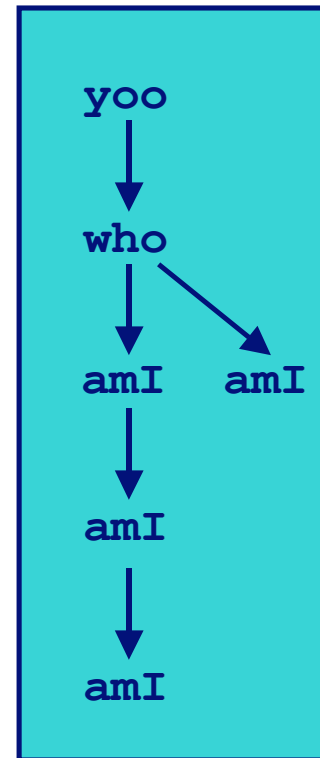

Stack Frames

Contents

- Local variables
- Return information
- Temporary space

Management

- Space allocated when enter procedure
 - “Set-up” code
- Deallocated when return
 - “Finish” code

Pointers

- Stack pointer `%esp` indicates stack top
- Frame pointer `%ebp` indicates start of current frame

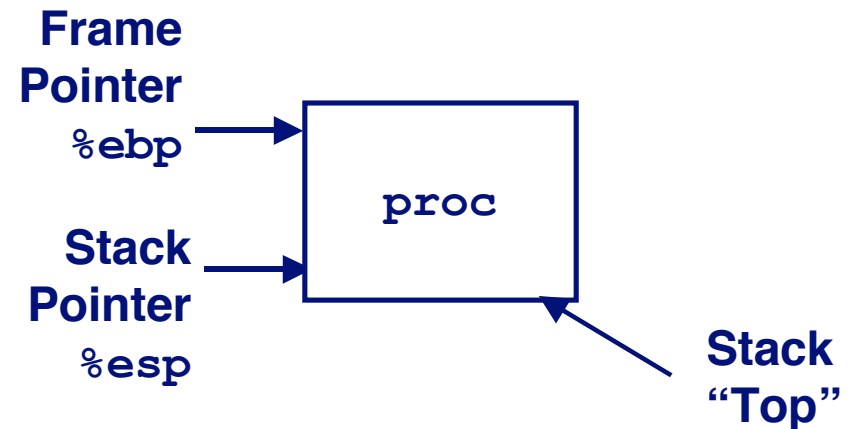
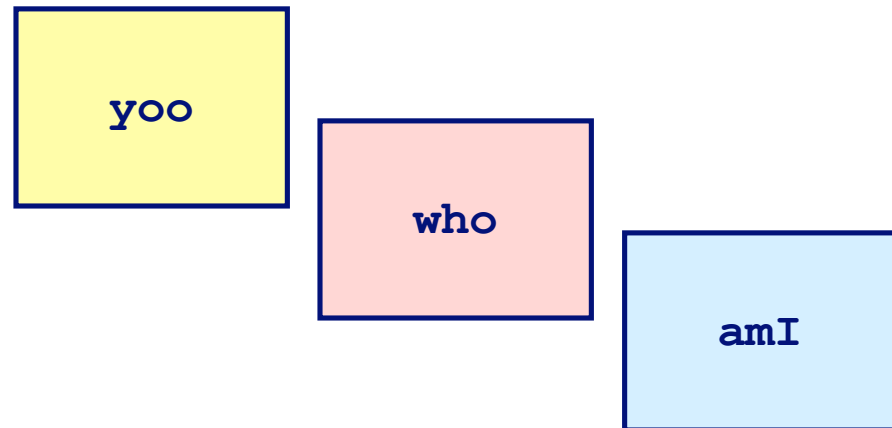

Stack Operation

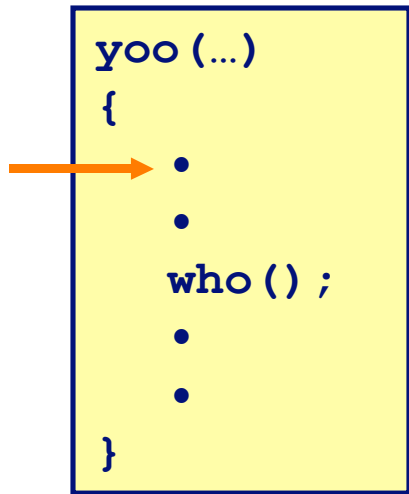

Call Chain

yoo

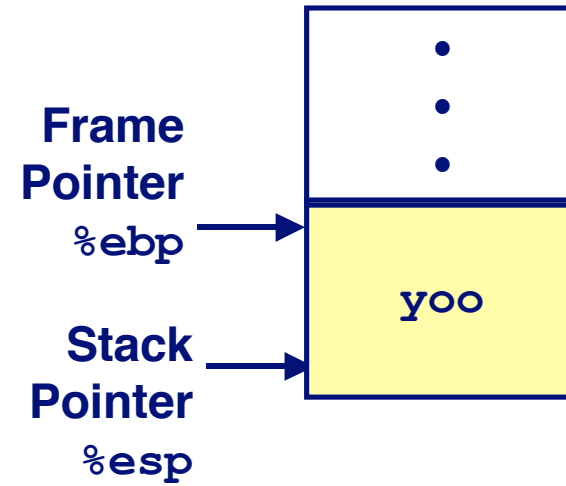

Stack Operation

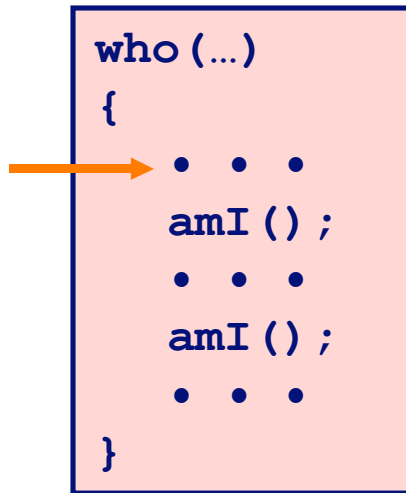

Call Chain

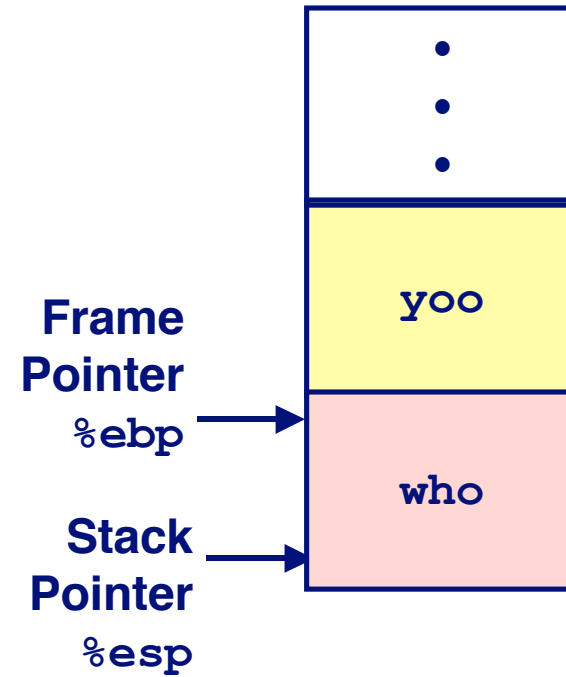
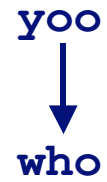

Stack Operation

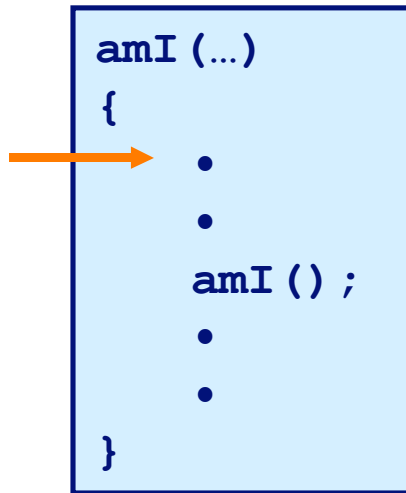

Call Chain

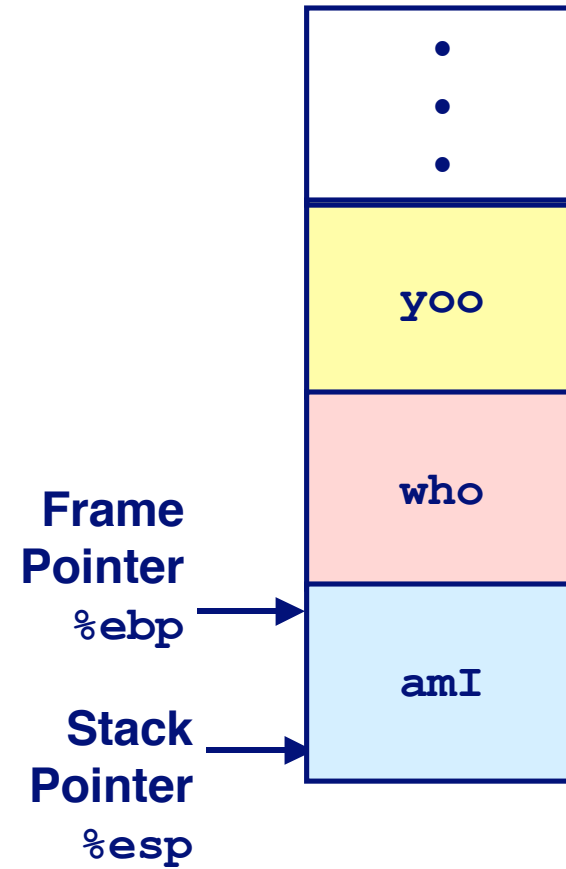

Stack Operation

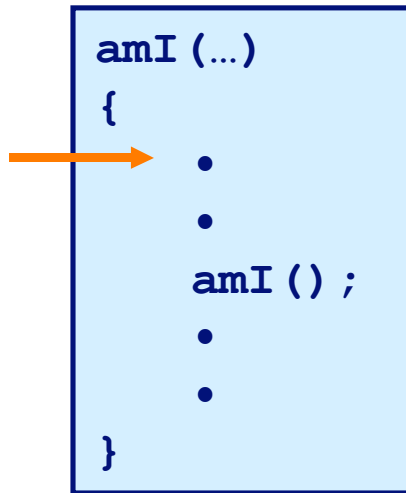

Call Chain

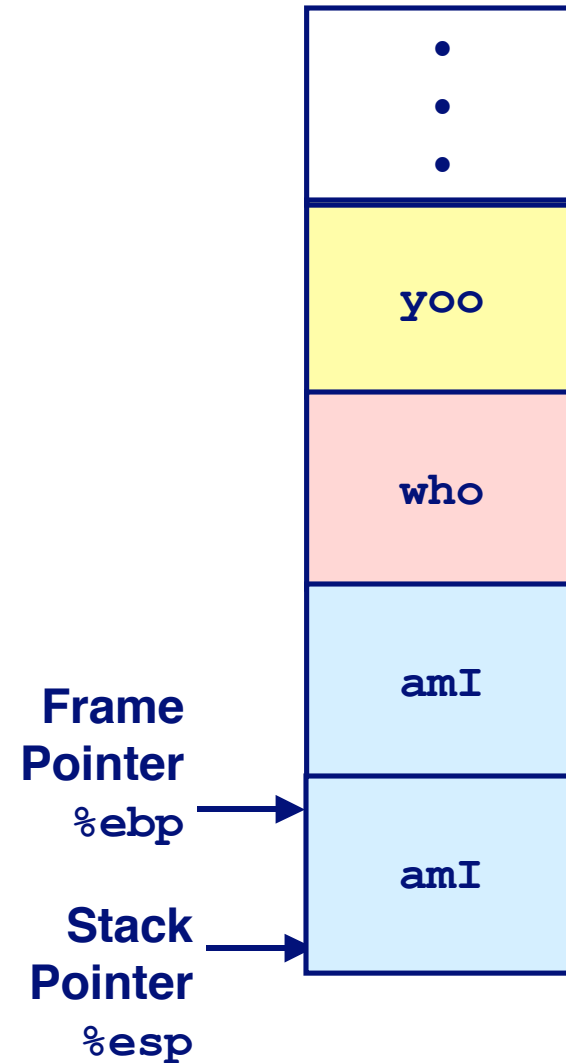

Stack Operation

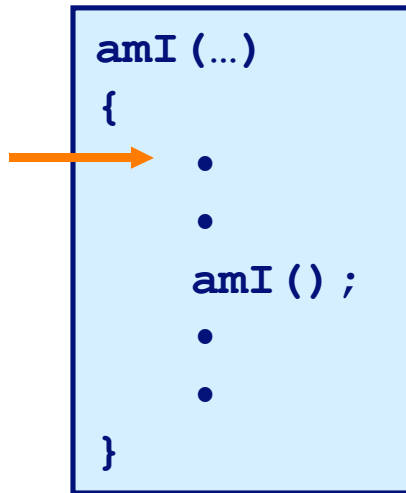

Call Chain

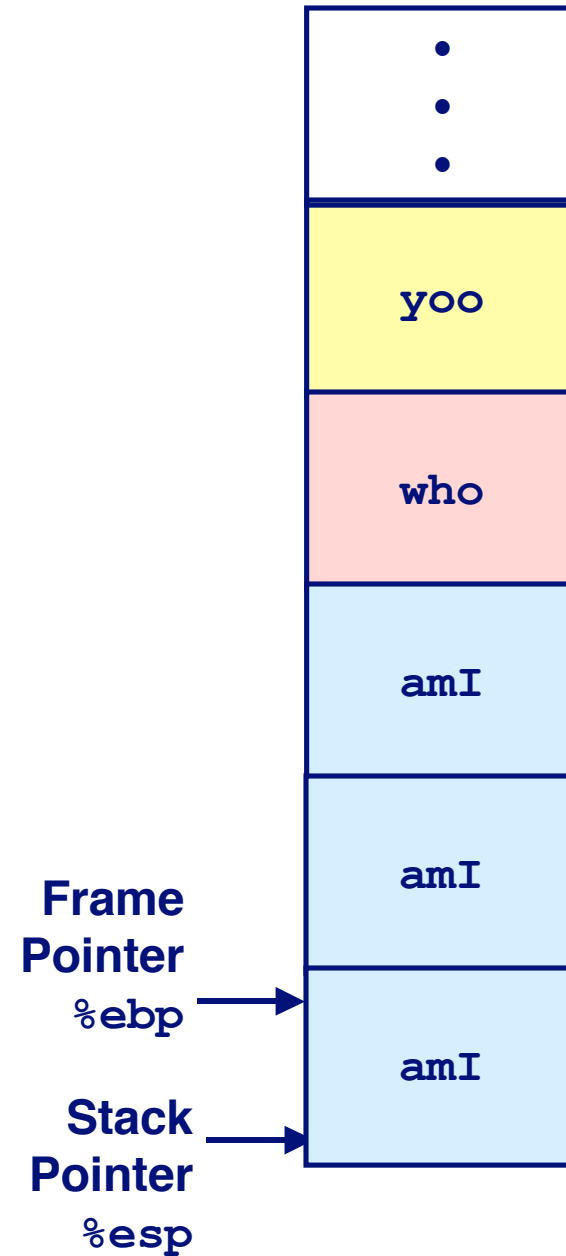

Stack Operation

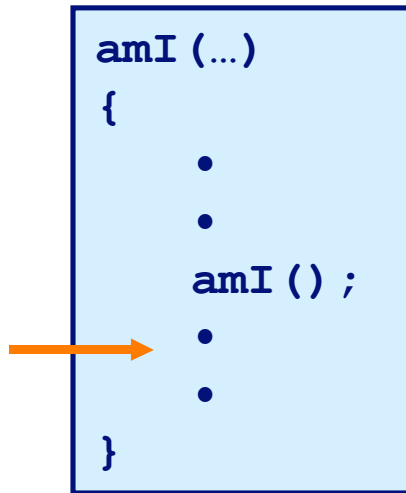

Call Chain

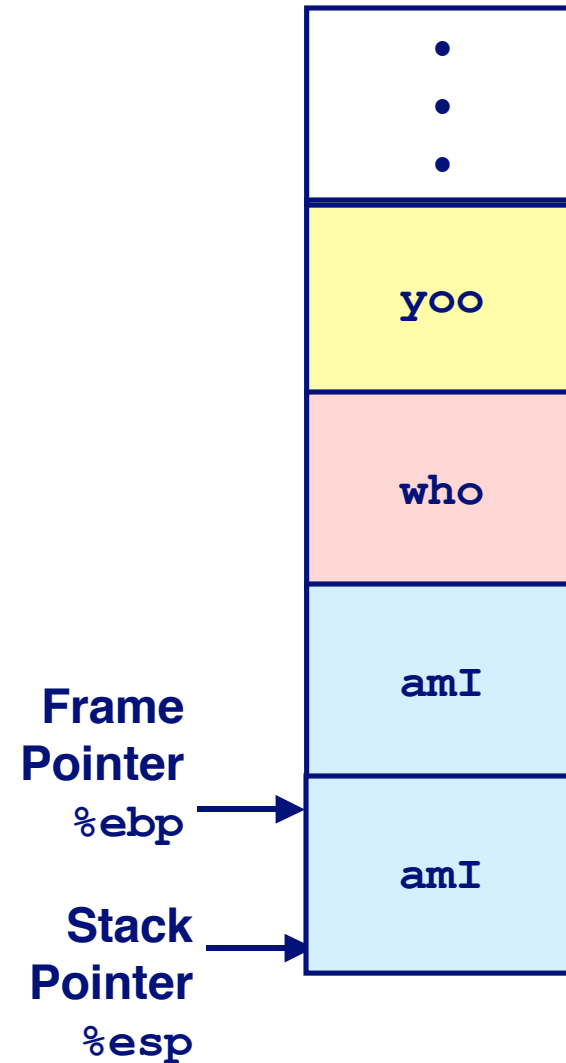

Stack Operation

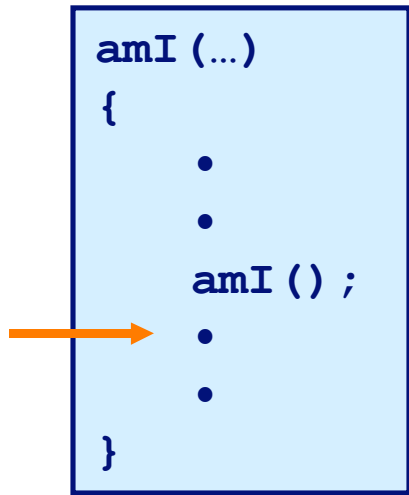

Call Chain

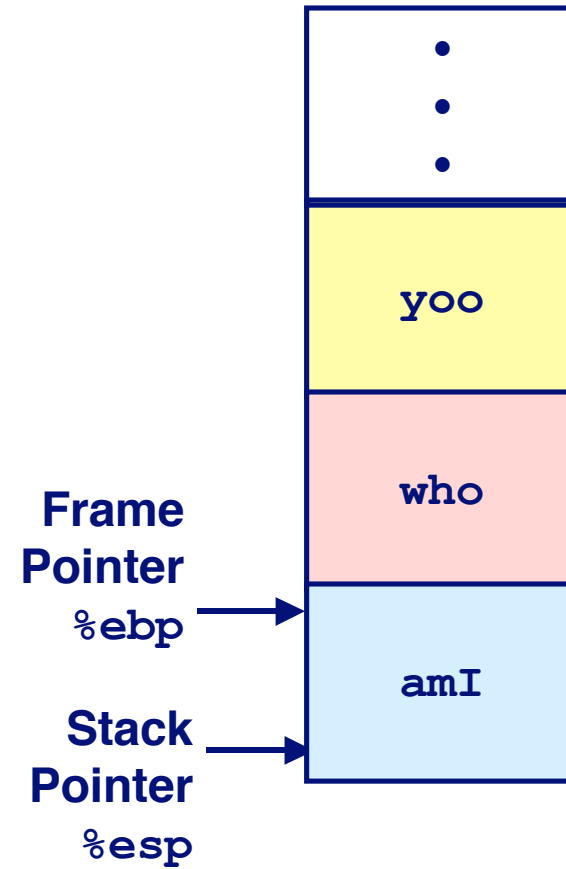

Stack Operation

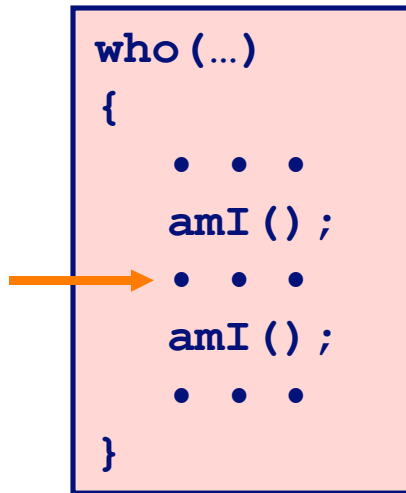

Call Chain

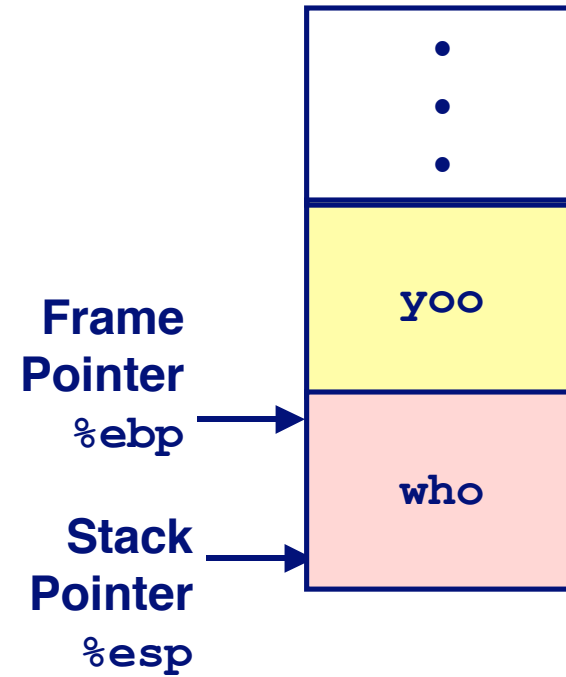

Stack Operation

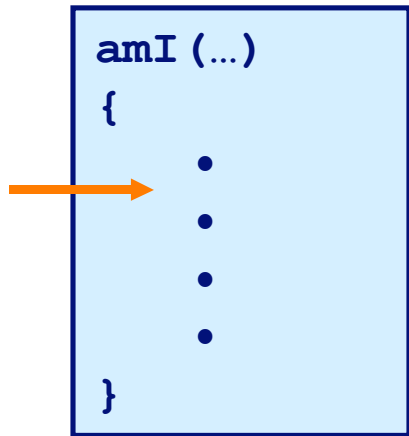

Call Chain

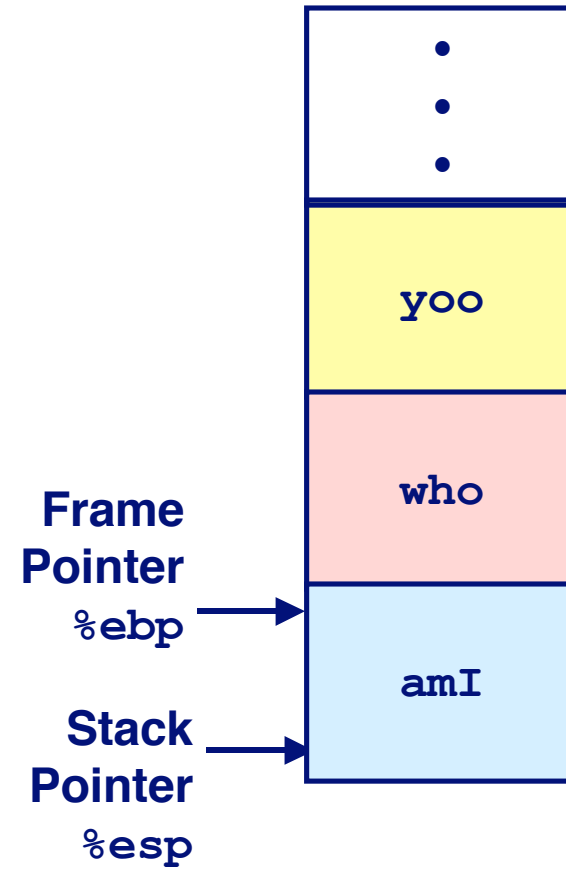
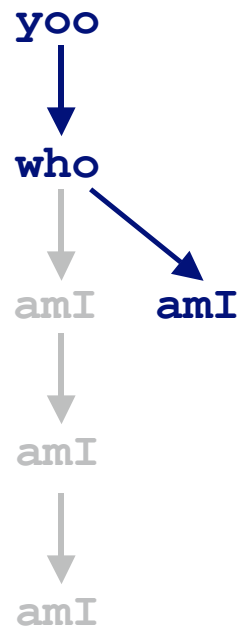

Stack Operation

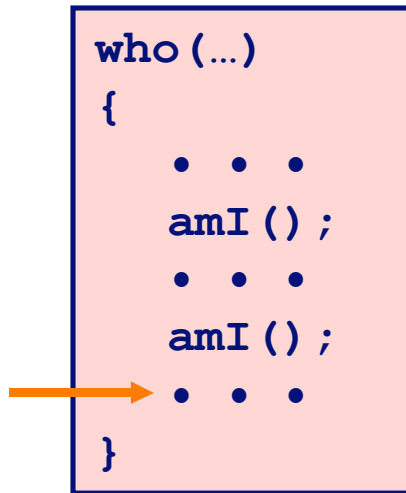

Call Chain

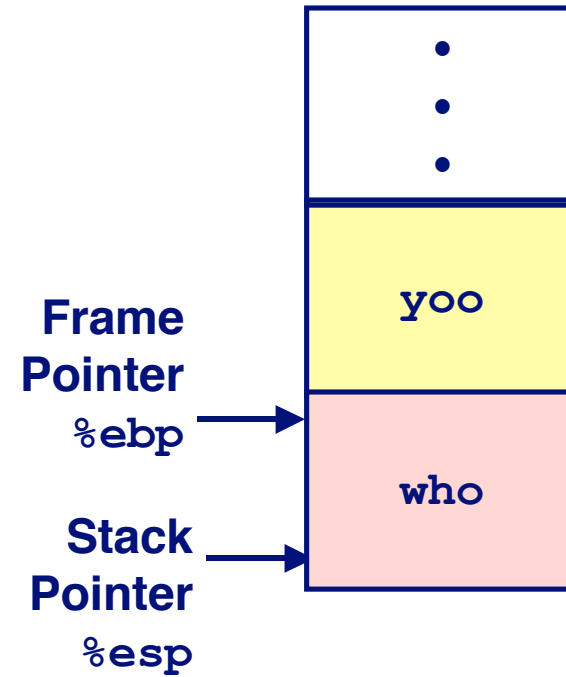
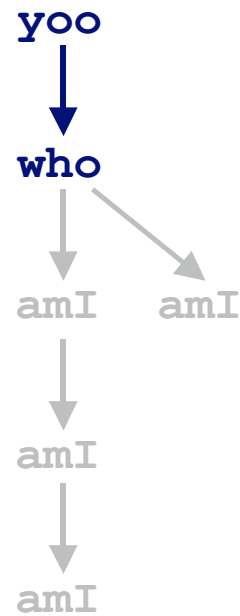

Stack Operation

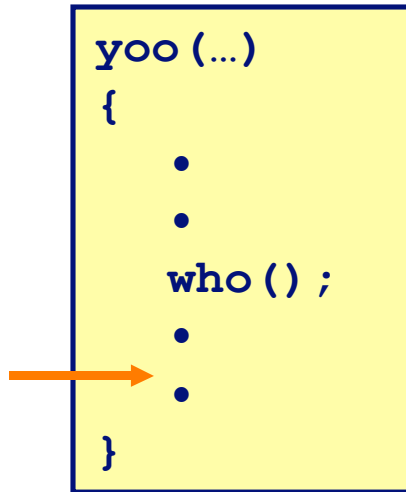

Call Chain

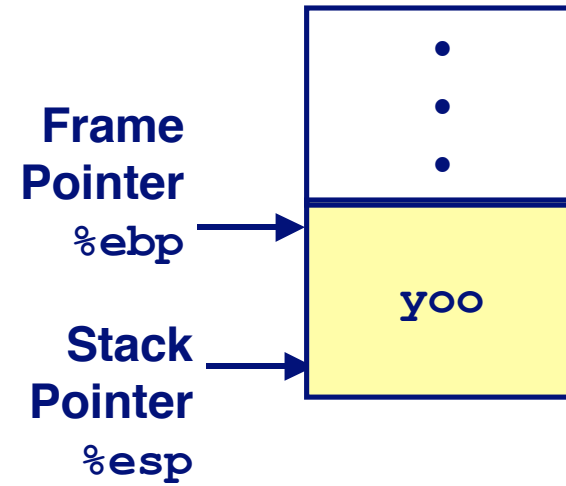
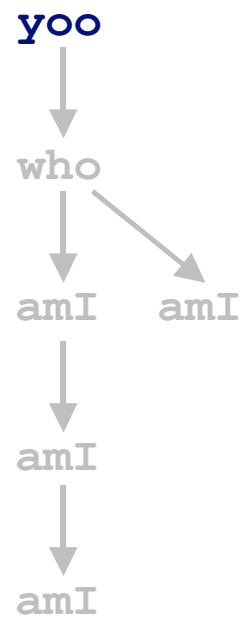

IA32/Linux Stack Frame

Current Stack Frame (“Top” to Bottom)

- Parameters for function about to call
 - “Argument build”
- Local variables
 - If can't keep in registers
- Saved register context
- Old frame pointer

Caller Stack Frame

- Return address
 - Pushed by `call` instruction
- Arguments for this call

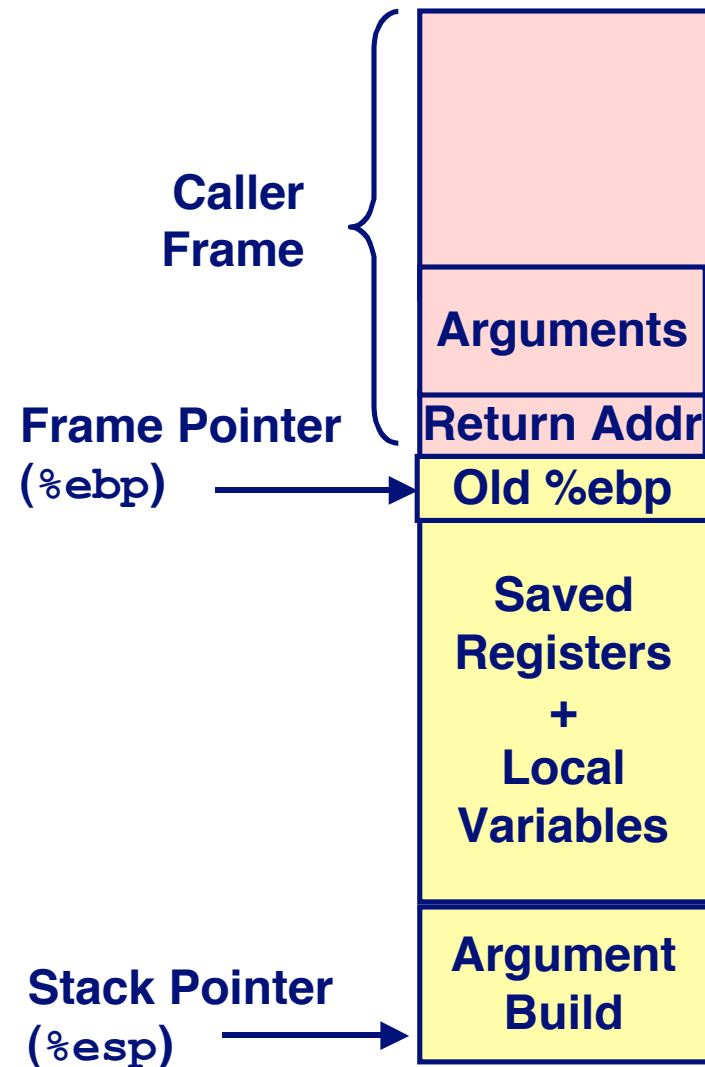

Revisiting swap

```
int zip1 = 15213;
int zip2 = 91125;

void call_swap()
{
    swap(&zip1, &zip2);
}
```

```
void swap(int *xp, int *yp)
{
    int t0 = *xp;
    int t1 = *yp;
    *xp = t1;
    *yp = t0;
}
```

Calling swap from call_swap

```
call_swap:
    . . .
    pushl $zip2    # Global Var
    pushl $zip1    # Global Var
    call swap
    . . .
```

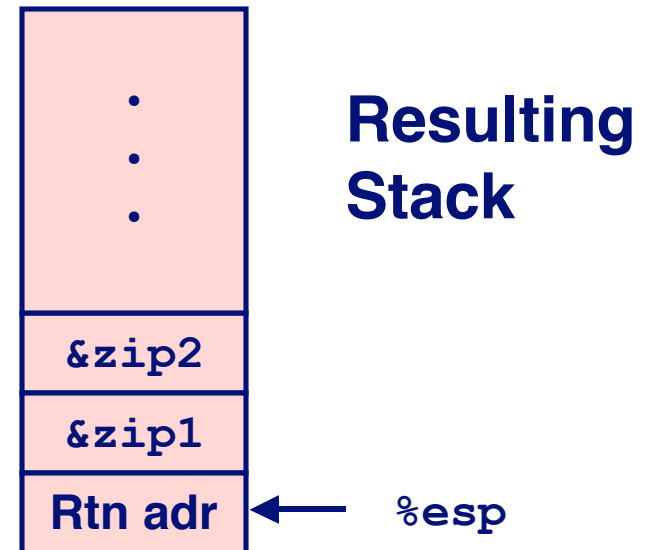

Revisiting swap

```
void swap(int *xp, int *yp)
{
    int t0 = *xp;
    int t1 = *yp;
    *xp = t1;
    *yp = t0;
}
```

swap:

```
    pushl %ebp
    movl %esp, %ebp
    pushl %ebx
} Set Up

    movl 12(%ebp), %ecx
    movl 8(%ebp), %edx
    movl (%ecx), %eax
    movl (%edx), %ebx
    movl %eax, (%edx)
    movl %ebx, (%ecx)
} Body

    movl -4(%ebp), %ebx
    movl %ebp, %esp
    popl %ebp
    ret
} Finish
```

swap Setup #1

Entering Stack

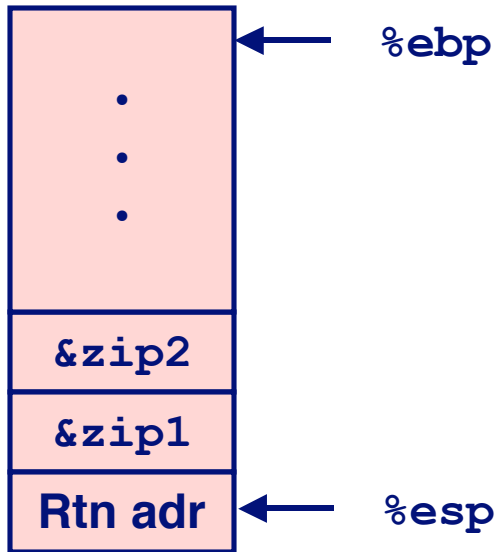

Resulting Stack

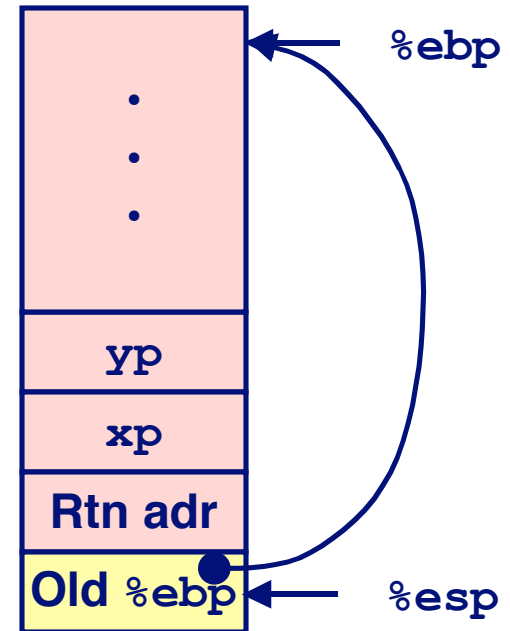

swap:

```
pushl %ebp  
movl %esp,%ebp  
pushl %ebx
```

swap Setup #2

Entering Stack

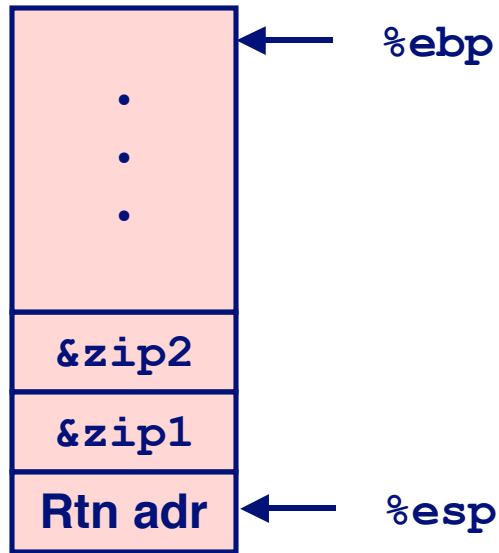

Resulting Stack

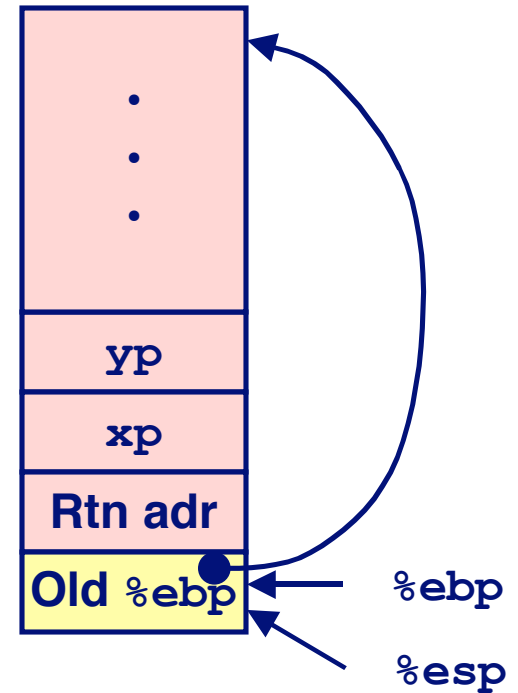

swap :

```
pushl %ebp  
movl %esp, %ebp  
pushl %ebx
```

swap Setup #3

Entering Stack

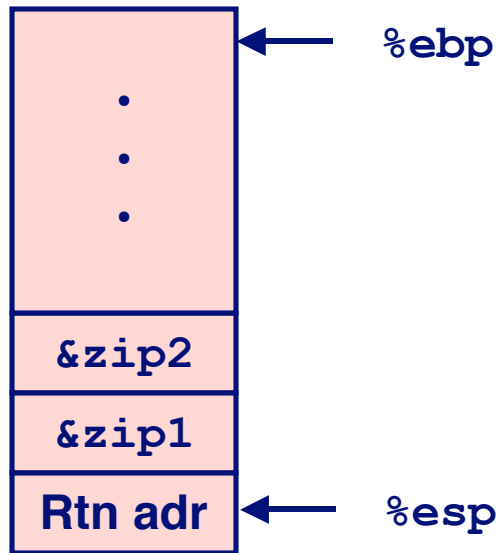

Resulting Stack

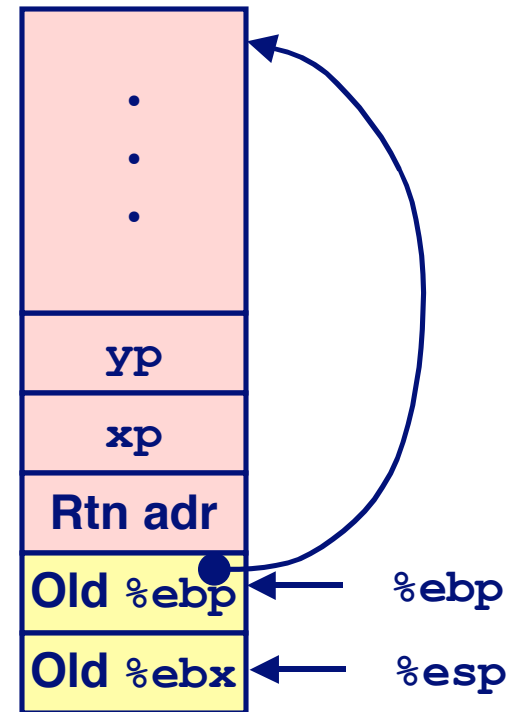

swap :

```
    pushl %ebp  
    movl %esp,%ebp  
    pushl %ebx
```

Effect of swap Setup

Entering Stack

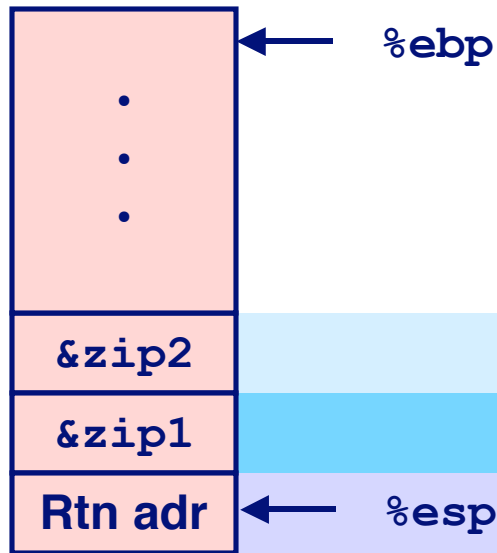

Offset
(relative to %ebp)

12

8

4

0

Resulting Stack

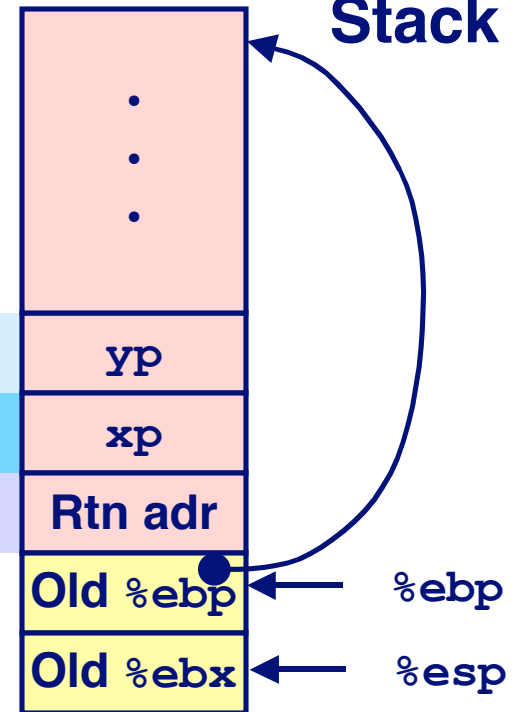

```

movl 12(%ebp), %ecx # get yp
movl 8(%ebp), %edx # get xp
. . .
    
```

} Body

swap Finish #1

swap's
Stack

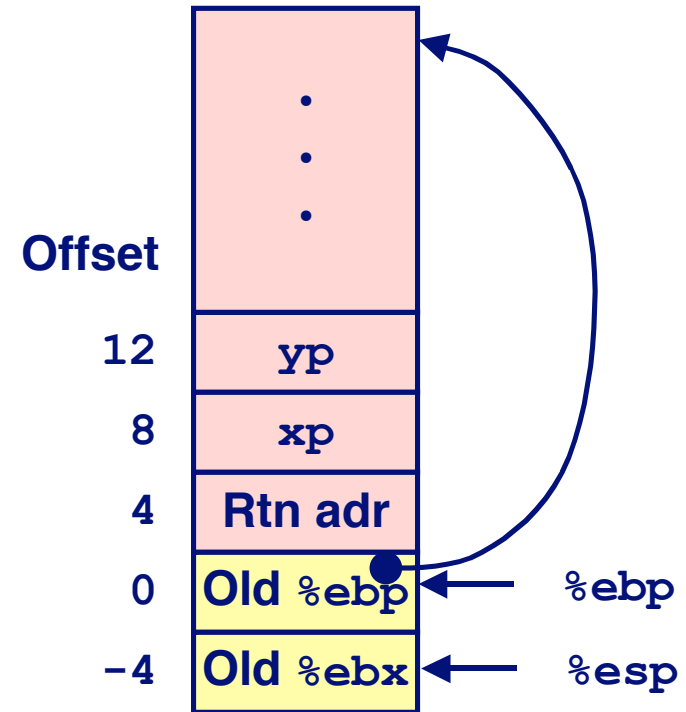
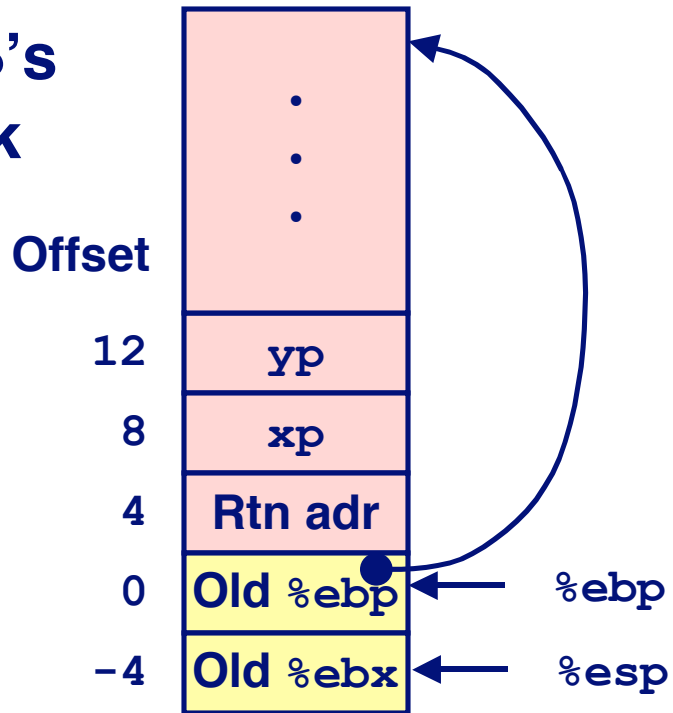

```
movl -4(%ebp), %ebx  
movl %ebp, %esp  
popl %ebp  
ret
```

Observation

- Saved & restored register %ebx

swap Finish #2

swap's Stack

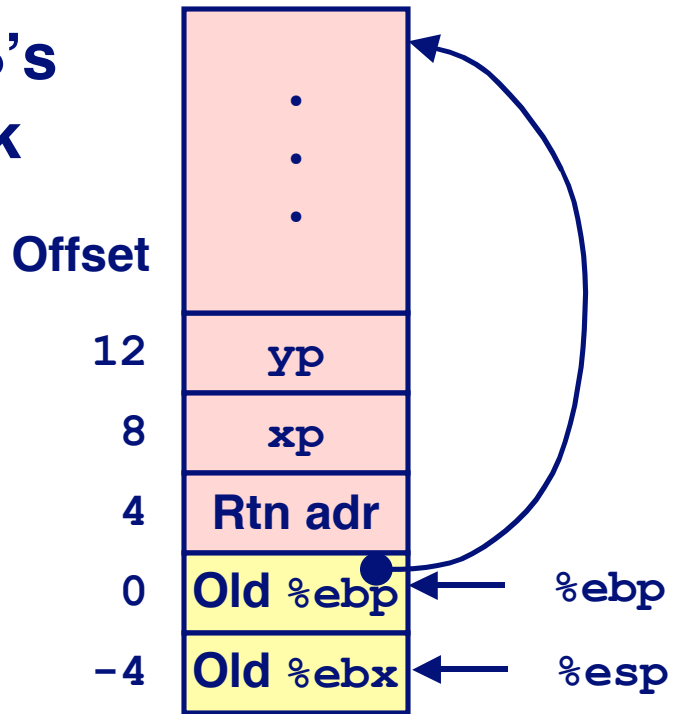

swap's Stack

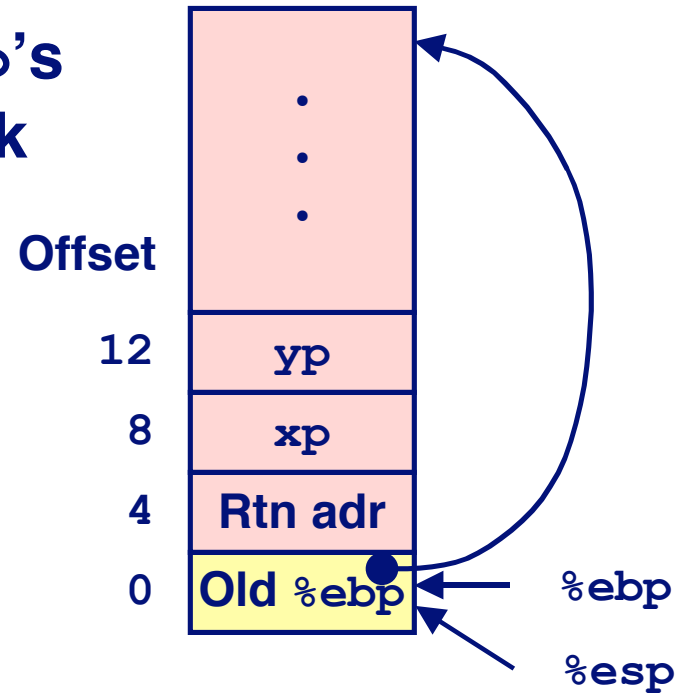

```
movl -4(%ebp), %ebx  
movl %ebp, %esp  
popl %ebp  
ret
```

swap Finish #3

swap's
Stack

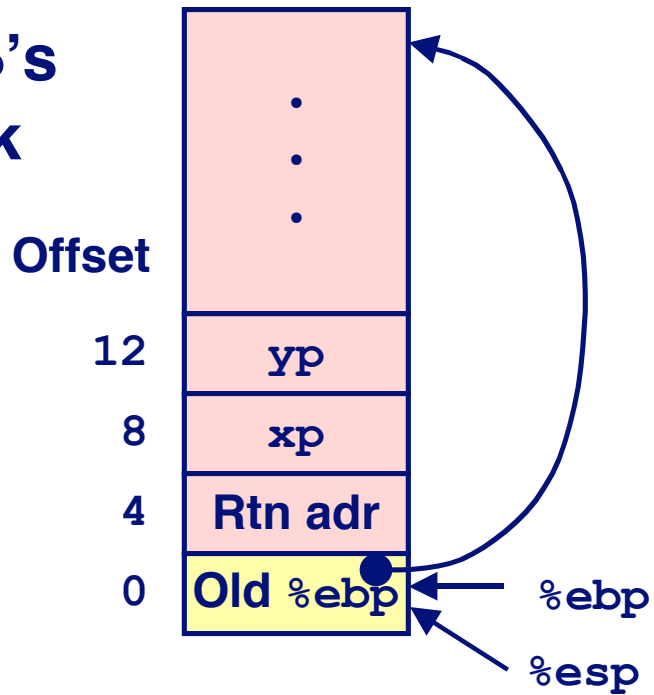

swap's
Stack

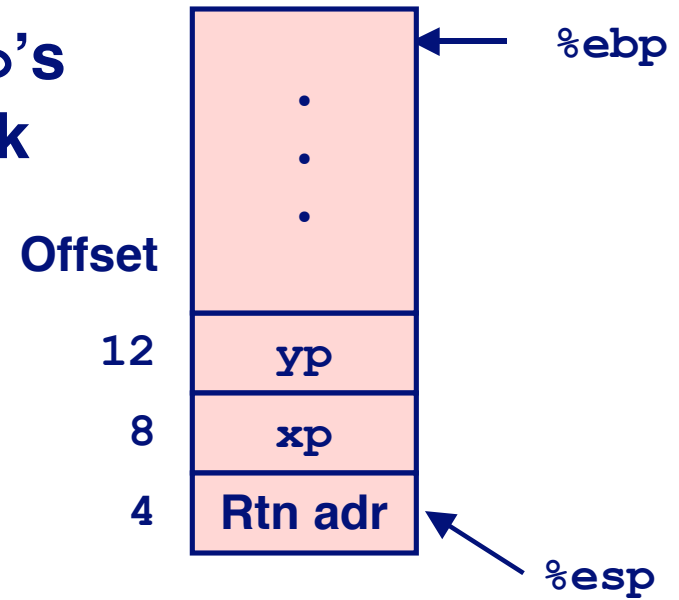

```
movl -4(%ebp), %ebx
movl %ebp, %esp
popl %ebp
ret
```

swap Finish #4

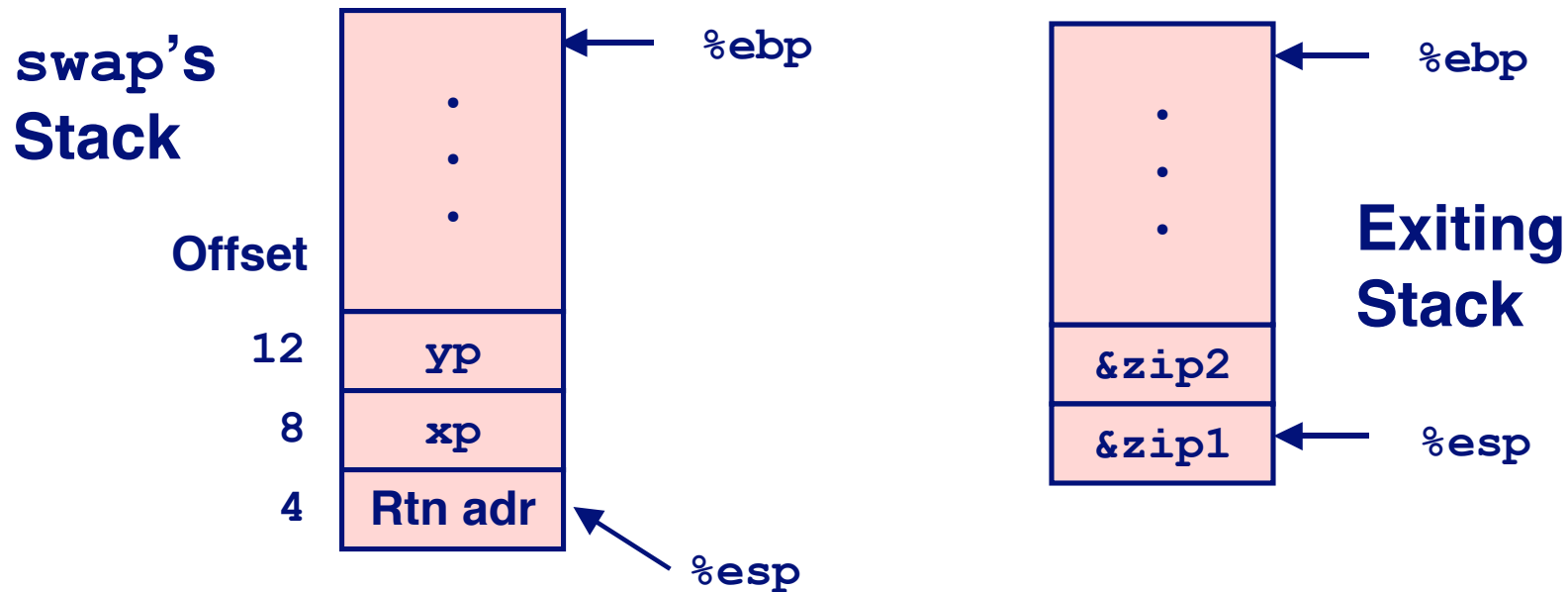

Observation

- Saved & restored register %ebx
- Didn't do so for %eax, %ecx, or %edx

```
movl -4(%ebp), %ebx
movl %ebp, %esp
popl %ebp
ret
```

Register Saving Conventions

When procedure `yoo` calls `who`:

- `yoo` is the *caller*, `who` is the *callee*

Can Register be Used for Temporary Storage?

```
yoo:  
  . . .  
  movl $15213, %edx  
  call who  
  addl %edx, %eax  
  . . .  
  ret
```

```
who:  
  . . .  
  movl 8(%ebp), %edx  
  addl $91125, %edx  
  . . .  
  ret
```

- Contents of register `%edx` overwritten by `who`

Register Saving Conventions

When procedure `yoo` calls `who`:

- `yoo` is the *caller*, `who` is the *callee*

Can Register be Used for Temporary Storage?

Conventions

- “Caller Save”
 - Caller saves temporary in its frame before calling
- “Callee Save”
 - Callee saves temporary in its frame before using

IA32/Linux Register Usage

Integer Registers

- Two have special uses
`%ebp`, `%esp`
- Three managed as callee-save
 - Old values saved on stack prior to using
`%ebx`, `%esi`, `%edi`
- Three managed as caller-save
 - Do what you please, but expect any callee to do so, as well
`%eax`, `%edx`, `%ecx`
- Register `%eax` also stores returned value

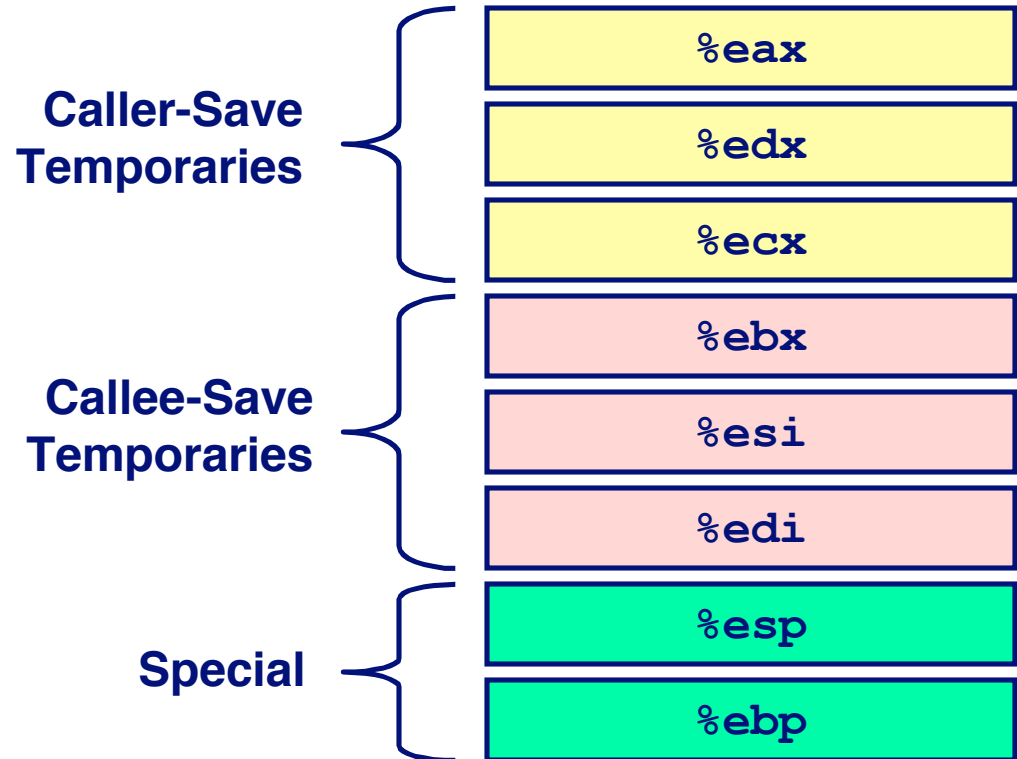

Recursive Factorial

```
int rfact(int x)
{
    int rval;
    if (x <= 1)
        return 1;
    rval = rfact(x-1);
    return rval * x;
}
```

Registers

- `%eax` used without first saving
- `%ebx` used, but save at beginning & restore at end

```
.globl rfact
.type
rfact,@function
rfact:
    pushl %ebp
    movl %esp,%ebp
    pushl %ebx
    movl 8(%ebp),%ebx
    cmpl $1,%ebx
    jle .L78
    leal -1(%ebx),%eax
    pushl %eax
    call rfact
    imull %ebx,%eax
    jmp .L79
    .align 4
.L78:
    movl $1,%eax
.L79:
    movl -4(%ebp),%ebx
    movl %ebp,%esp
    popl %ebp
    ret
```

Rfact Stack Setup

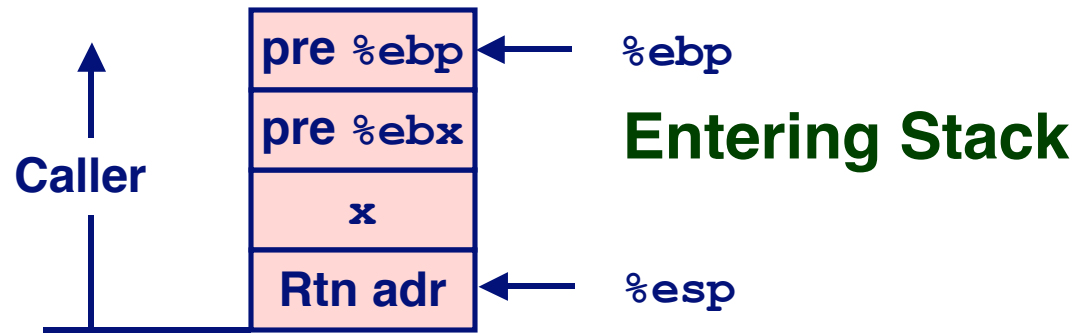

```
rfact:  
    pushl %ebp  
    movl %esp,%ebp  
    pushl %ebx
```

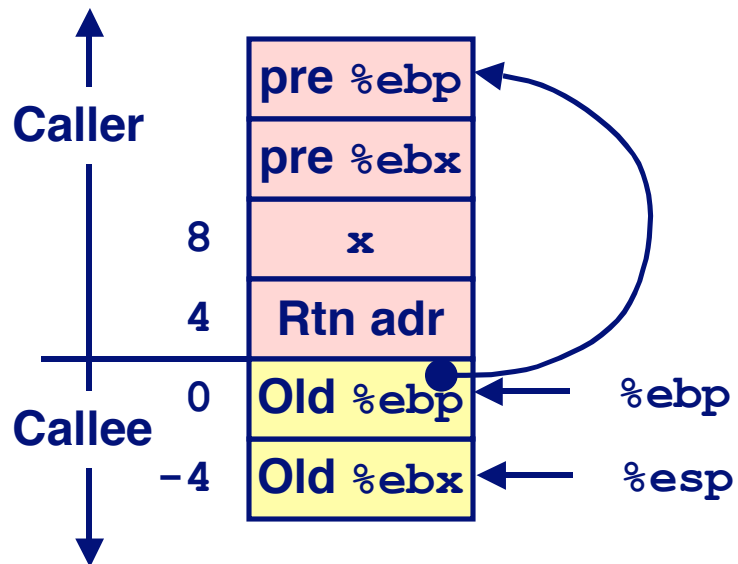

Rfact Body

Recursion

```
movl 8(%ebp),%ebx    # ebx = x
cmpl $1,%ebx        # Compare x : 1
jle .L78             # If <= goto Term
leal -1(%ebx),%eax   # eax = x-1
pushl %eax           # Push x-1
call rfact           # rfact(x-1)
imull %ebx,%eax      # rval * x
jmp .L79             # Goto done
.L78:                # Term:
    movl $1,%eax     # return val = 1
.L79:                # Done:
```

```
int rfact(int x)
{
    int rval;
    if (x <= 1)
        return 1;
    rval = rfact(x-1) ;
    return rval * x;
}
```

Registers

%ebx Stored value of x

%eax

- Temporary value of x-1
- Returned value from rfact(x-1)
- Returned value from this call

Rfact Recursion

```
leal -1(%ebx), %eax
```

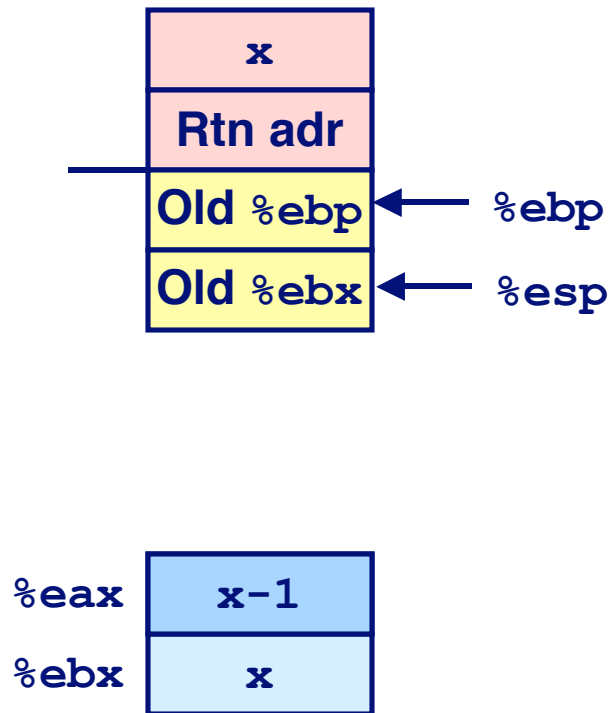

```
pushl %eax
```

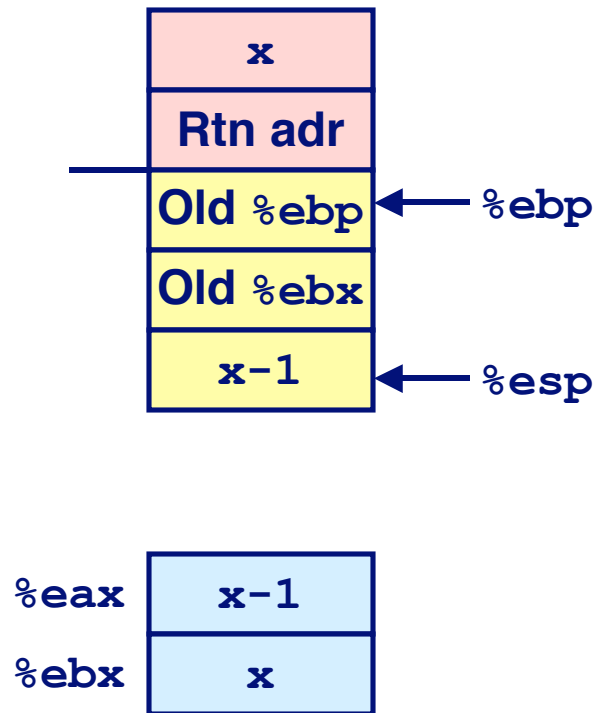

```
call rfact
```

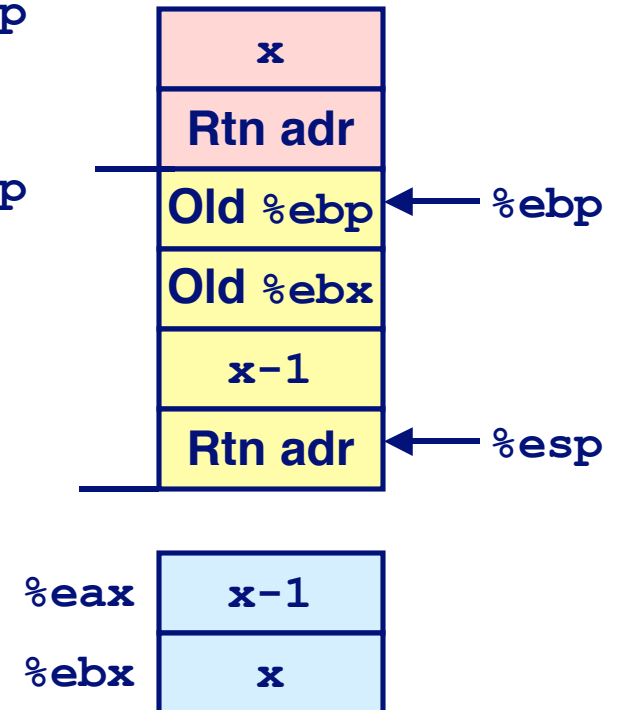

Rfact Result

Return from Call

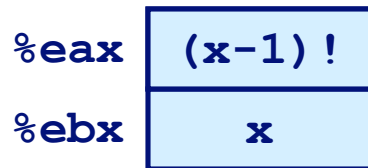
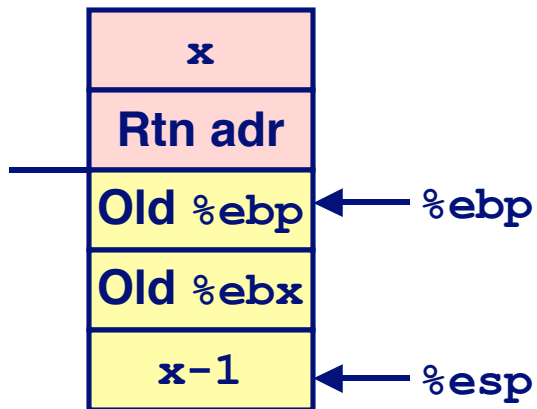

Assume that `rfact(x-1)` returns `(x-1)!` in register `%eax`

```
imull %ebx, %eax
```

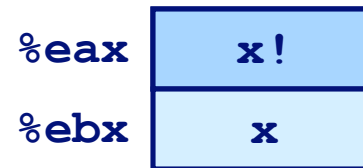
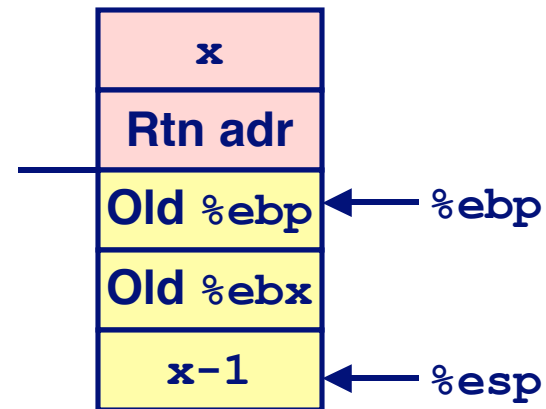

Rfact Completion

```

movl -4(%ebp), %ebx
movl %ebp, %esp
popl %ebp
ret
    
```

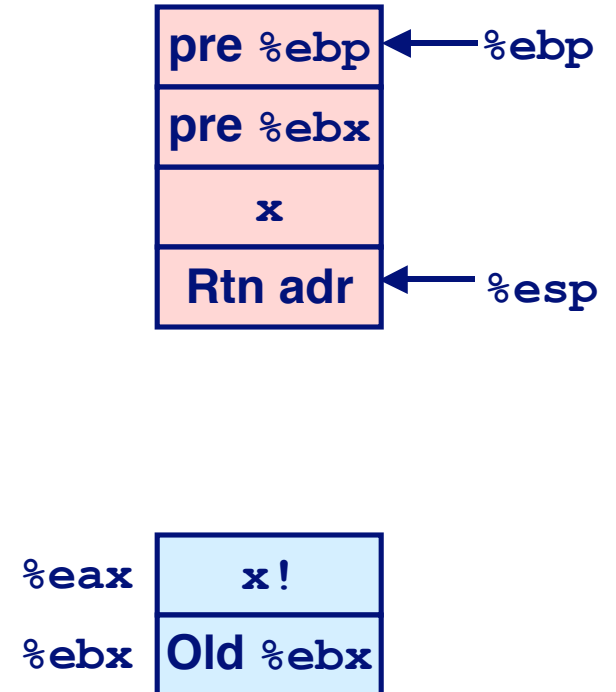
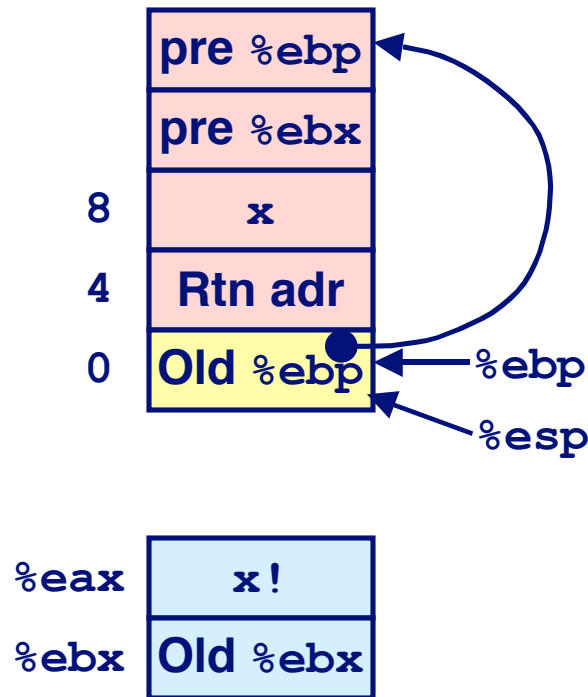
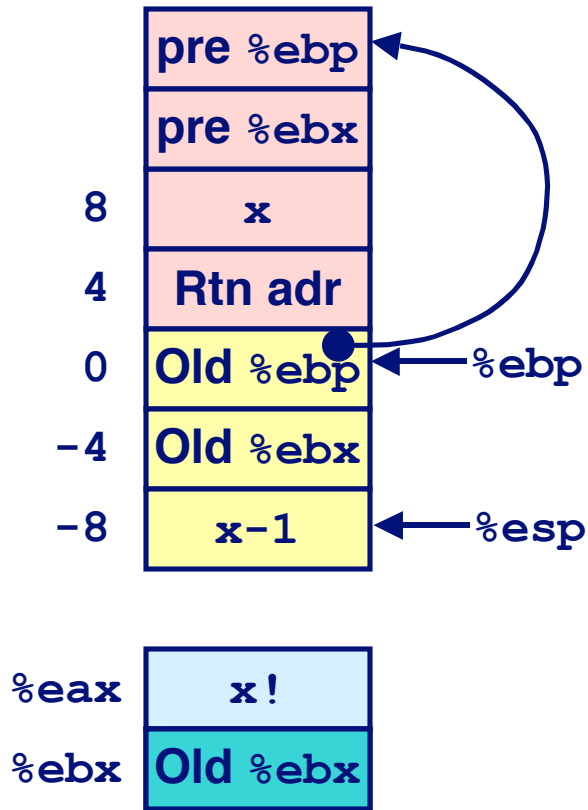

Pointer Code

Recursive Procedure

```
void s_helper
(int x, int *accum)
{
    if (x <= 1)
        return;
    else {
        int z = *accum * x;
        *accum = z;
        s_helper (x-1, accum);
    }
}
```

Top-Level Call

```
int sfact(int x)
{
    int val = 1;
    s_helper(x, &val);
    return val;
}
```

- Pass pointer to update location

Creating & Initializing Pointer

Initial part of `sfact`

```
_sfact:  
  pushl %ebp          # Save %ebp  
  movl  %esp,%ebp     # Set %ebp  
  subl  $16,%esp      # Add 16 bytes  
  movl  8(%ebp),%edx   # edx = x  
  movl  $1,-4(%ebp)   # val = 1
```

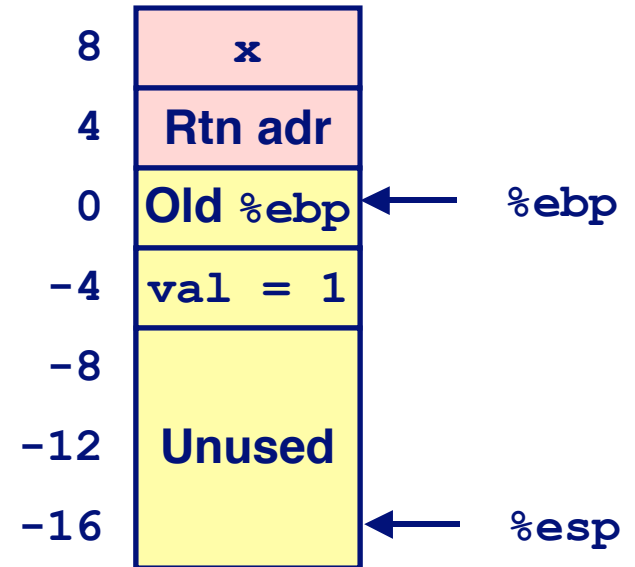

Using Stack for Local Variable

- Variable `val` must be stored on stack
 - Need to create pointer to it
- Compute pointer as `-4(%ebp)`
- Push on stack as second argument

```
int sfact(int x)  
{  
    int val = 1;  
    s_helper(x, &val);  
    return val;  
}
```

Passing Pointer

Calling `s_helper` from `sfact`

```
leal -4(%ebp),%eax # Compute &val
pushl %eax         # Push on stack
pushl %edx         # Push x
call s_helper      # call
movl -4(%ebp),%eax # Return val
. . .             # Finish
```

```
int sfact(int x)
{
    int val = 1;
    s_helper(x, &val);
    return val;
}
```

Stack at time of call

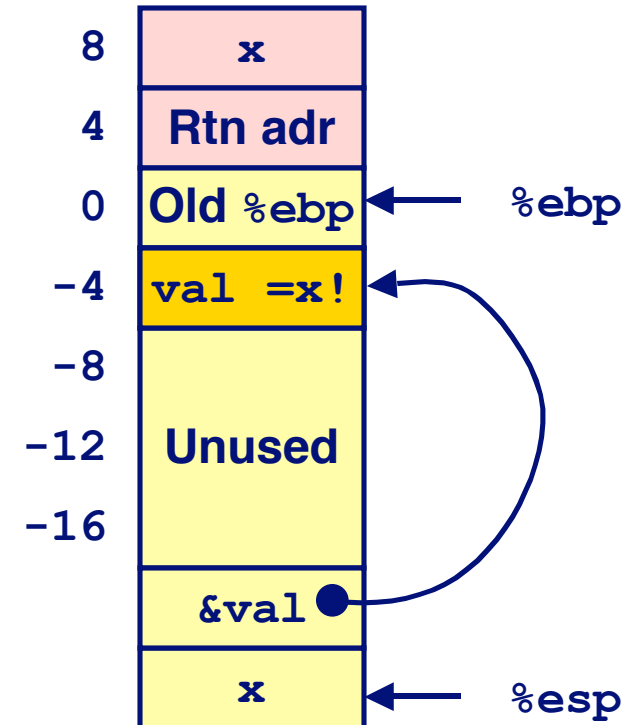

Using Pointer

```
void s_helper
(int x, int *accum)
{
    . . .
    int z = *accum * x;
    *accum = z;
    . . .
}
```

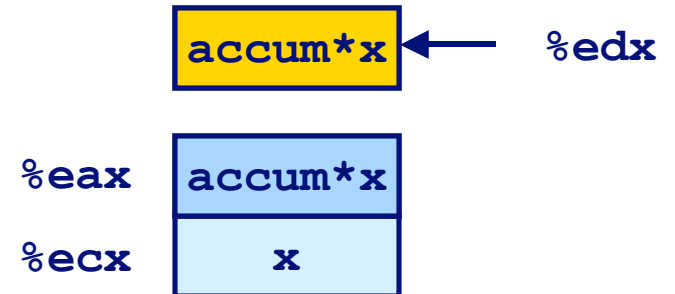

```
. . .
movl %ecx,%eax    # z = x
imull (%edx),%eax # z *= *accum
movl %eax,(%edx)  # *accum = z
. . .
```

- Register `%ecx` holds `x`
- Register `%edx` holds pointer to `accum`
 - Use access `(%edx)` to reference memory

Summary

The Stack Makes Recursion Work

- Private storage for each *instance* of procedure call
 - Instantiations don't clobber each other
 - Addressing of locals + arguments can be relative to stack positions
- Can be managed by stack discipline
 - Procedures return in inverse order of calls

IA32 Procedures Combination of Instructions + Conventions

- Call / Ret instructions
- Register usage conventions
 - Caller / Callee save
 - `%ebp` and `%esp`
- Stack frame organization conventions