



Parallel CSE Applications

Abhinav Bhatele, Department of Computer Science



UNIVERSITY OF
MARYLAND

Announcements

- Assignment 6 (CUDA) for extra credit due on Dec 6 | 1:59 pm
 - Please name tarball as LastName-FirstName-assign6.tar.gz

Molecular Dynamics

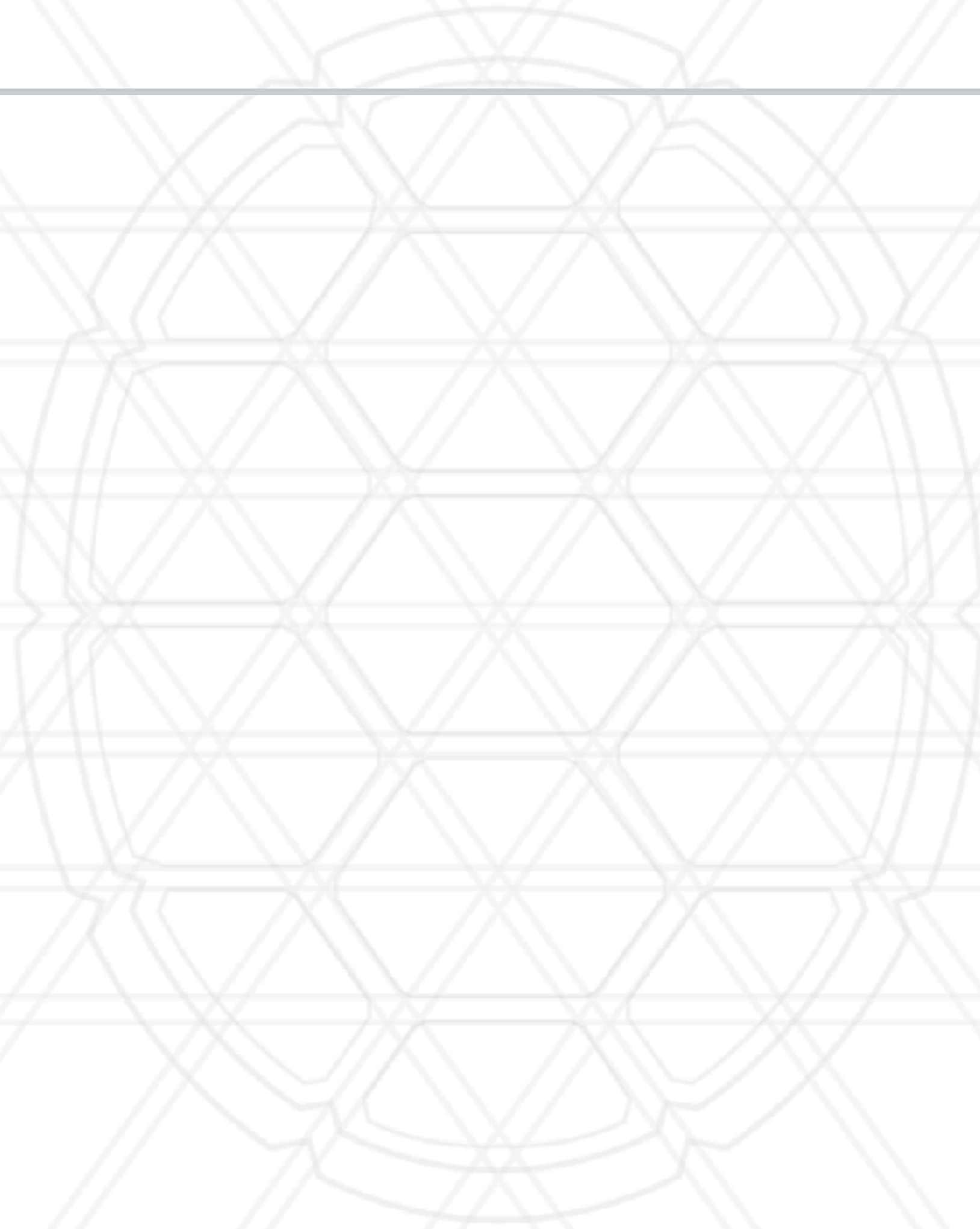

Molecular Dynamics

- Calculate trajectories of atoms and molecules by solving Newton's equations of motions

Molecular Dynamics

- Calculate trajectories of atoms and molecules by solving Newton's equations of motions
- Force calculations
 - Bonded interactions: bonds, angles, dihedrals
 - Non-bonded interactions: van der Waal's and electrostatic forces

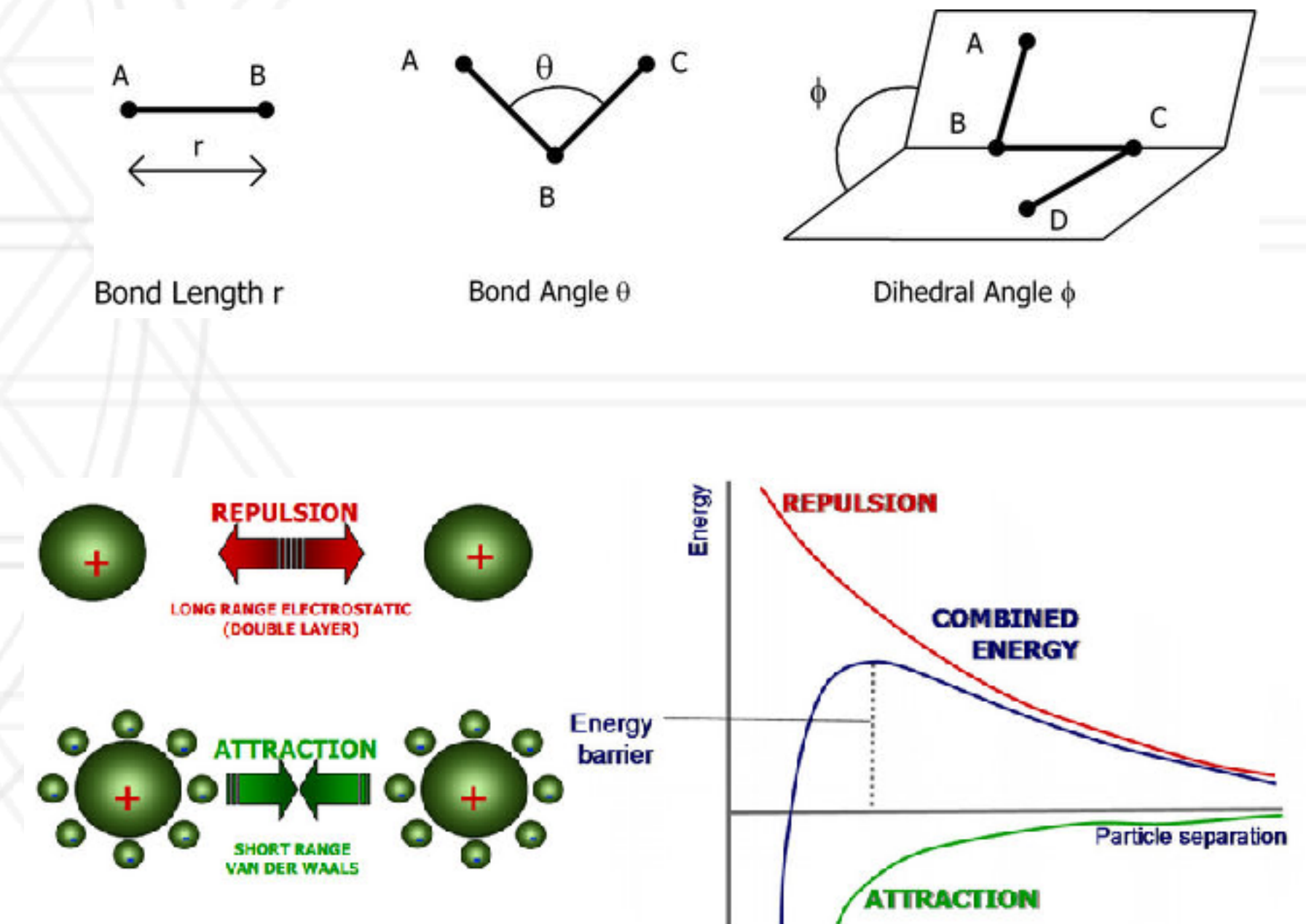

Molecular Dynamics

- Calculate trajectories of atoms and molecules by solving Newton's equations of motions
- Force calculations
 - Bonded interactions: bonds, angles, dihedrals
 - Non-bonded interactions: van der Waal's and electrostatic forces
- Number of atoms: thousands to millions

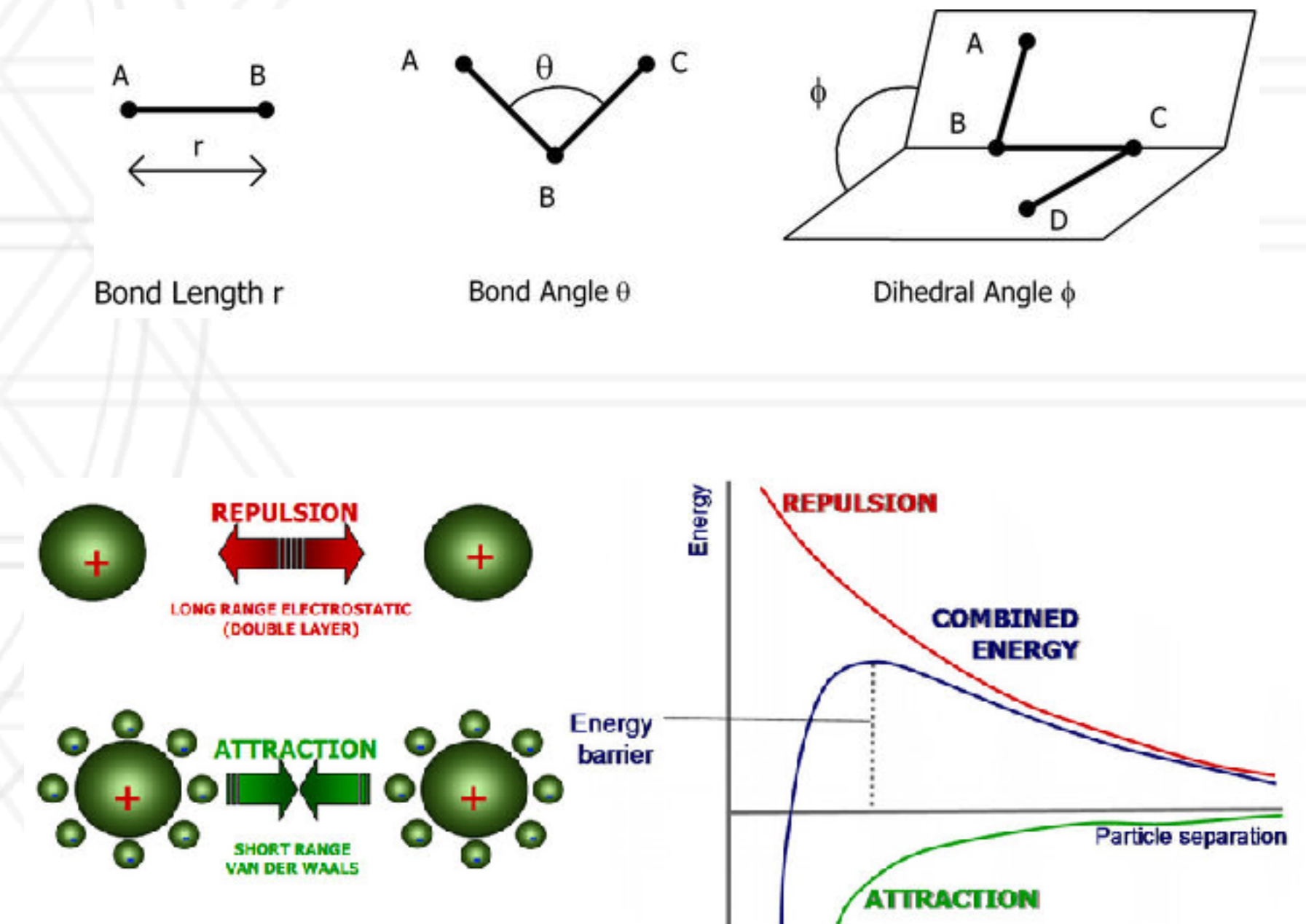

Molecular Dynamics

- Calculate trajectories of atoms and molecules by solving Newton's equations of motions
- Force calculations
 - Bonded interactions: bonds, angles, dihedrals
 - Non-bonded interactions: van der Waal's and electrostatic forces
- Number of atoms: thousands to millions
- Simulation step: ~ 1 femtosecond (10^{-15} s)

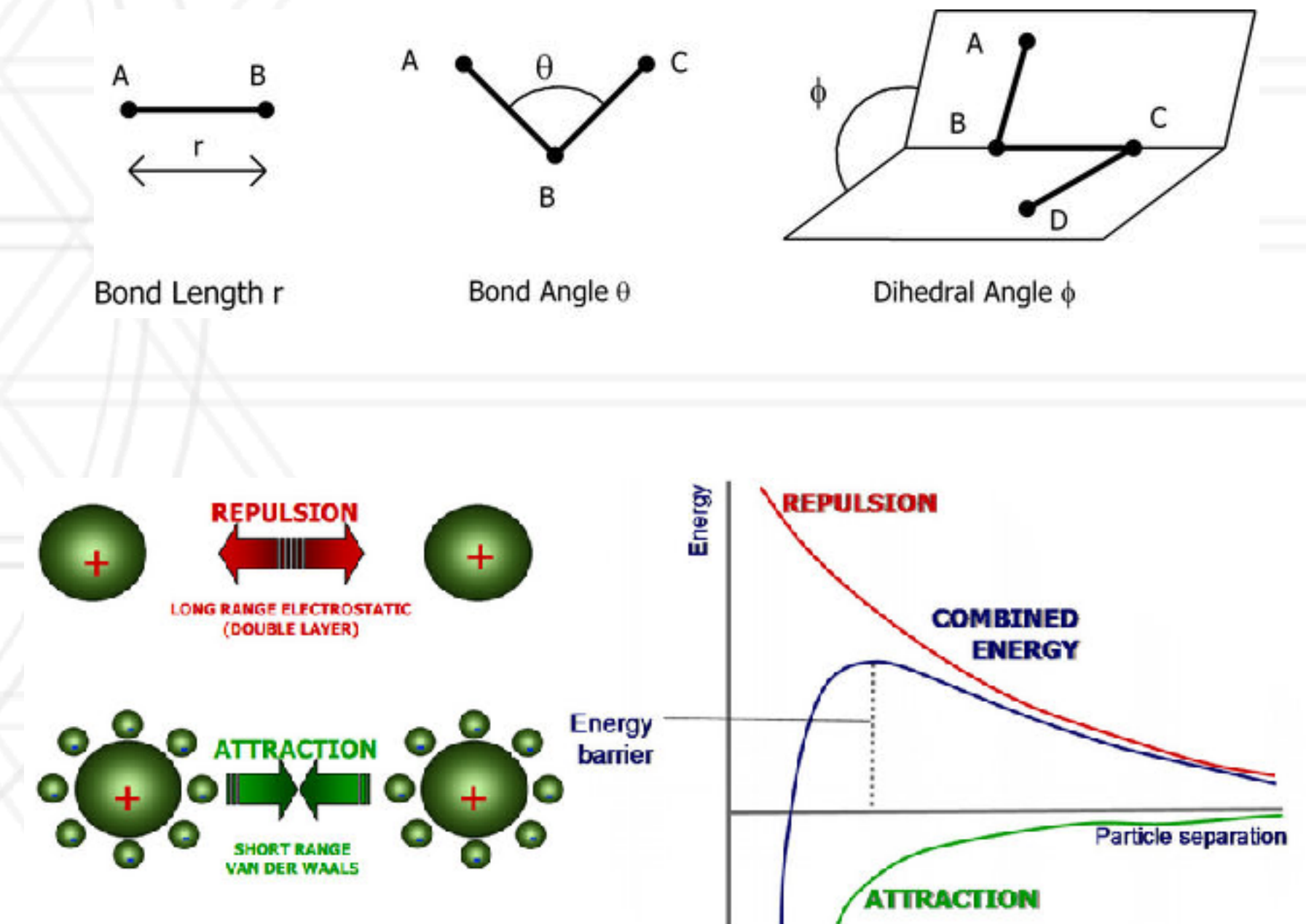

Sequential Algorithm

- At every step, calculate forces on each atom
 - Calculate bonded and short-range forces every step
 - Calculate long-range non-bonded forces every few time steps (using PME or P3M etc.)
- Particle mesh Ewald (PME) summation:
 - Calculate long-range interactions in Fourier space
- Calculate velocities and new positions
- Repeat ...

Traditional approaches to parallelization

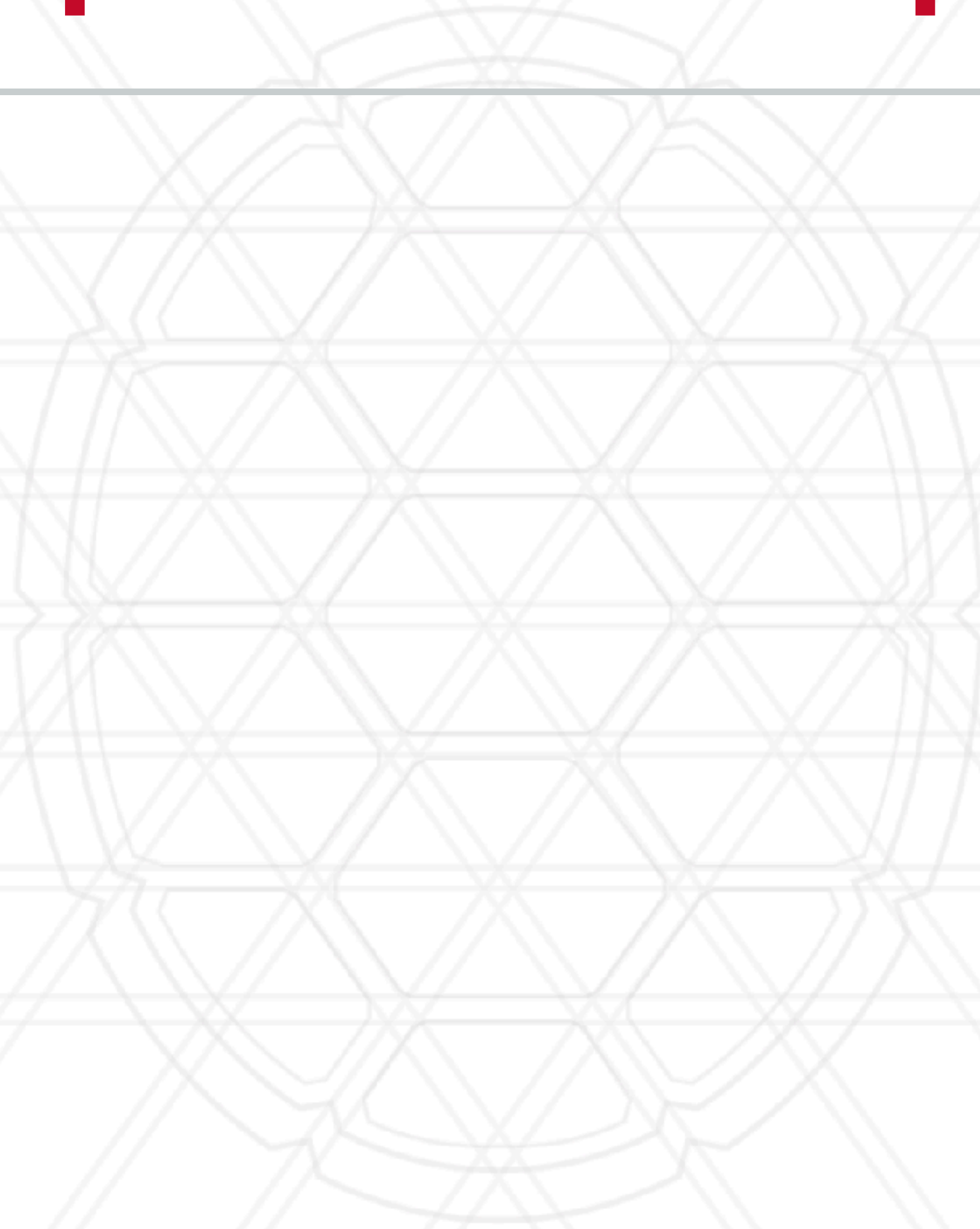

Traditional approaches to parallelization

- Atom decomposition:
 - Partition the atoms across processes

Traditional approaches to parallelization

- Atom decomposition:
 - Partition the atoms across processes
- Force decomposition:
 - Distribute the force matrix to processes
 - Matrix is sparse and non-uniform

Traditional approaches to parallelization

- Atom decomposition:
 - Partition the atoms across processes
- Force decomposition:
 - Distribute the force matrix to processes
 - Matrix is sparse and non-uniform
- Spatial decomposition:
 - Assign a region of the 3D simulation space to each process

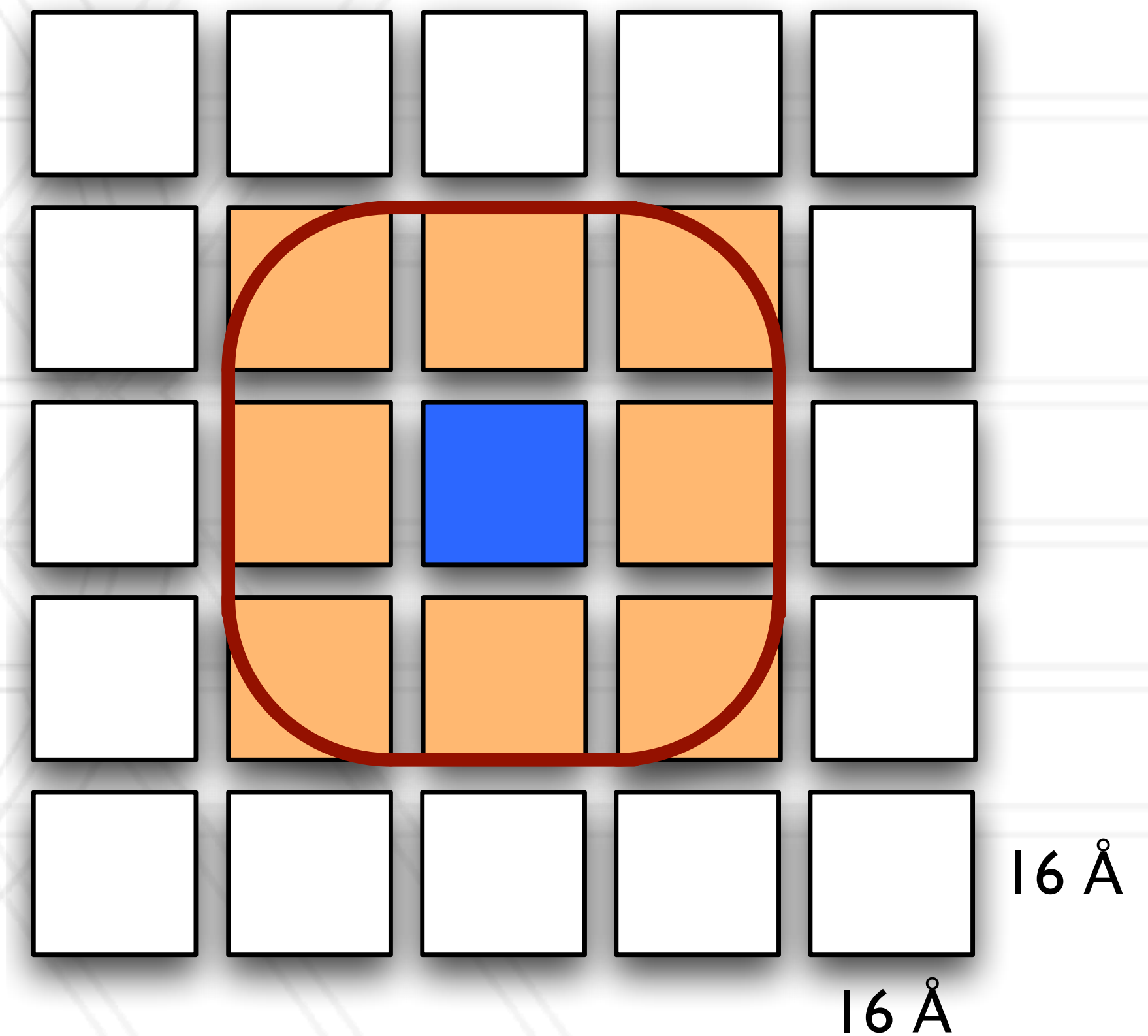

Hybrid parallelization

- Hybrid of spatial and force decomposition
- Decouple assignment of data and work to processes
- Distribute both atoms and the force calculations to different processes

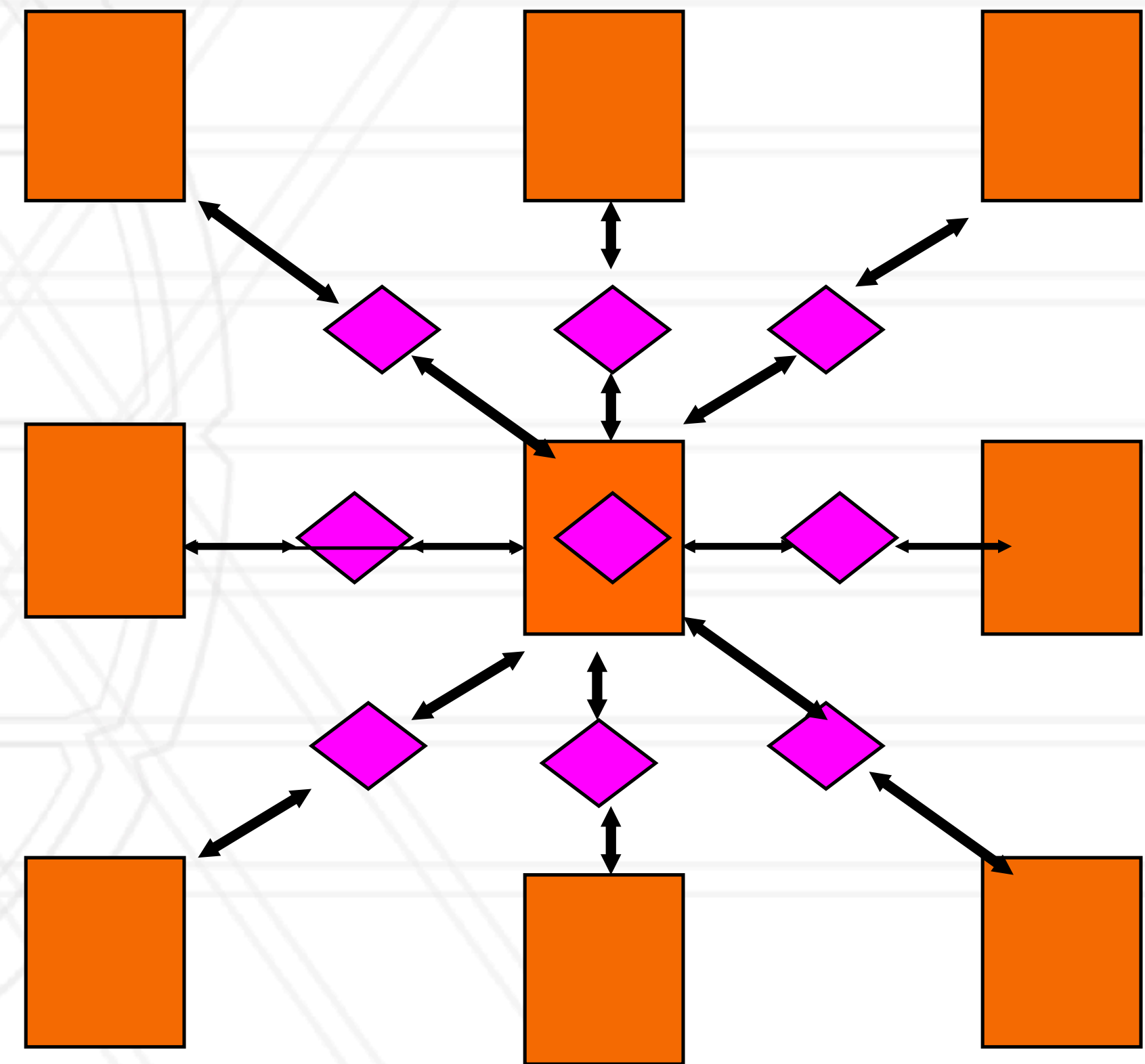

Neutral territory (NT) methods

- Desmond's mid-point method

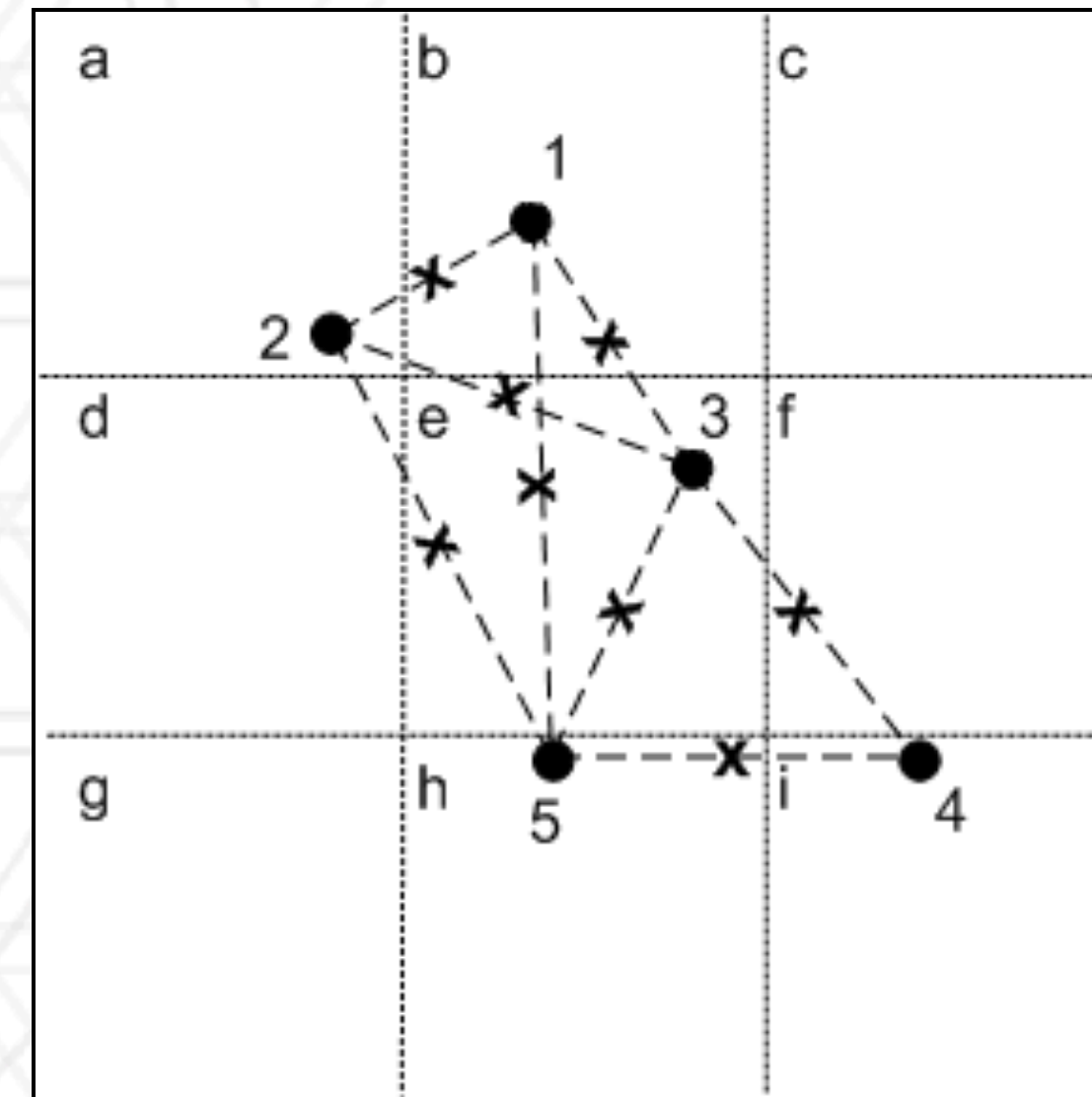
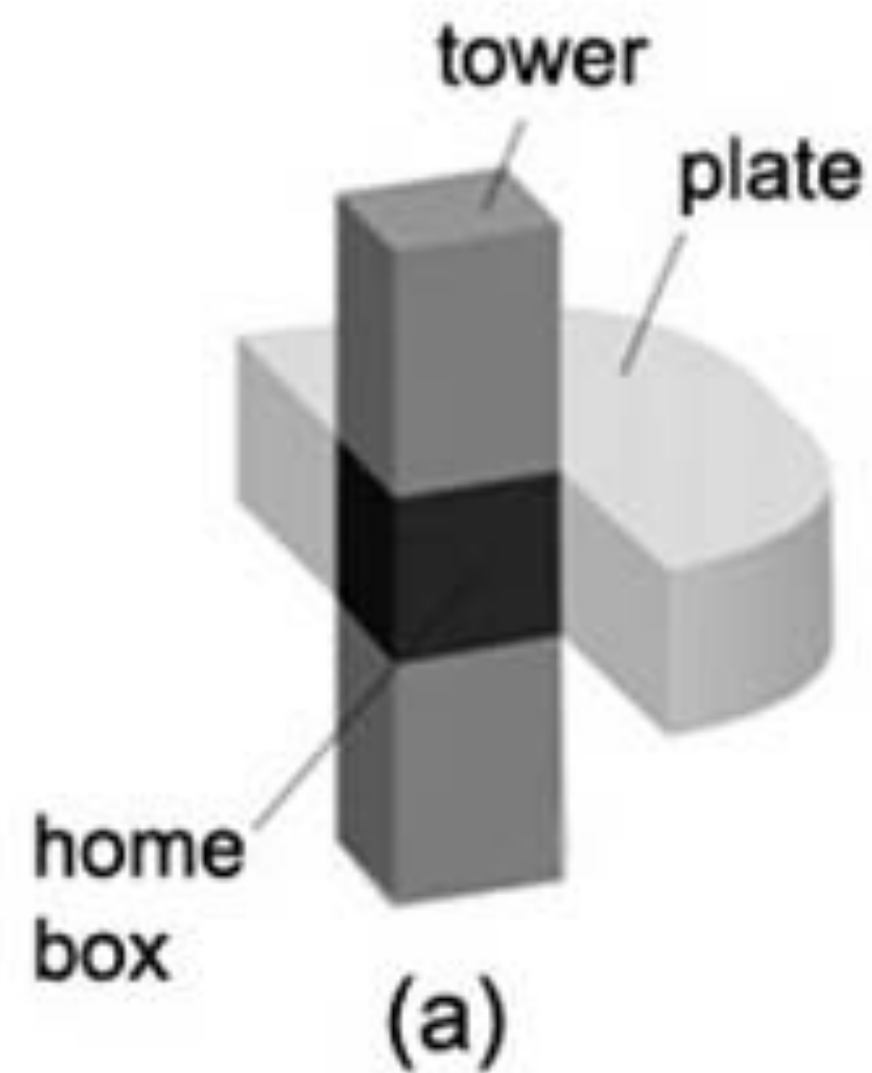

Particle mesh Ewald

- Replace direct force calculations by:
 - Calculate short-range forces in real space
 - Calculate long-range forces in Fourier space
- Create a 3D mesh/grid representing charge densities of atoms
 - Compute a 3D Fast Fourier Transform (FFT)
- FFT computes the discrete Fourier transform (DFT) or inverse DFT
 - Reduces the complexity from $O(N^2)$ to $O(N \log N)$

Parallelization of PME (3D FFT)

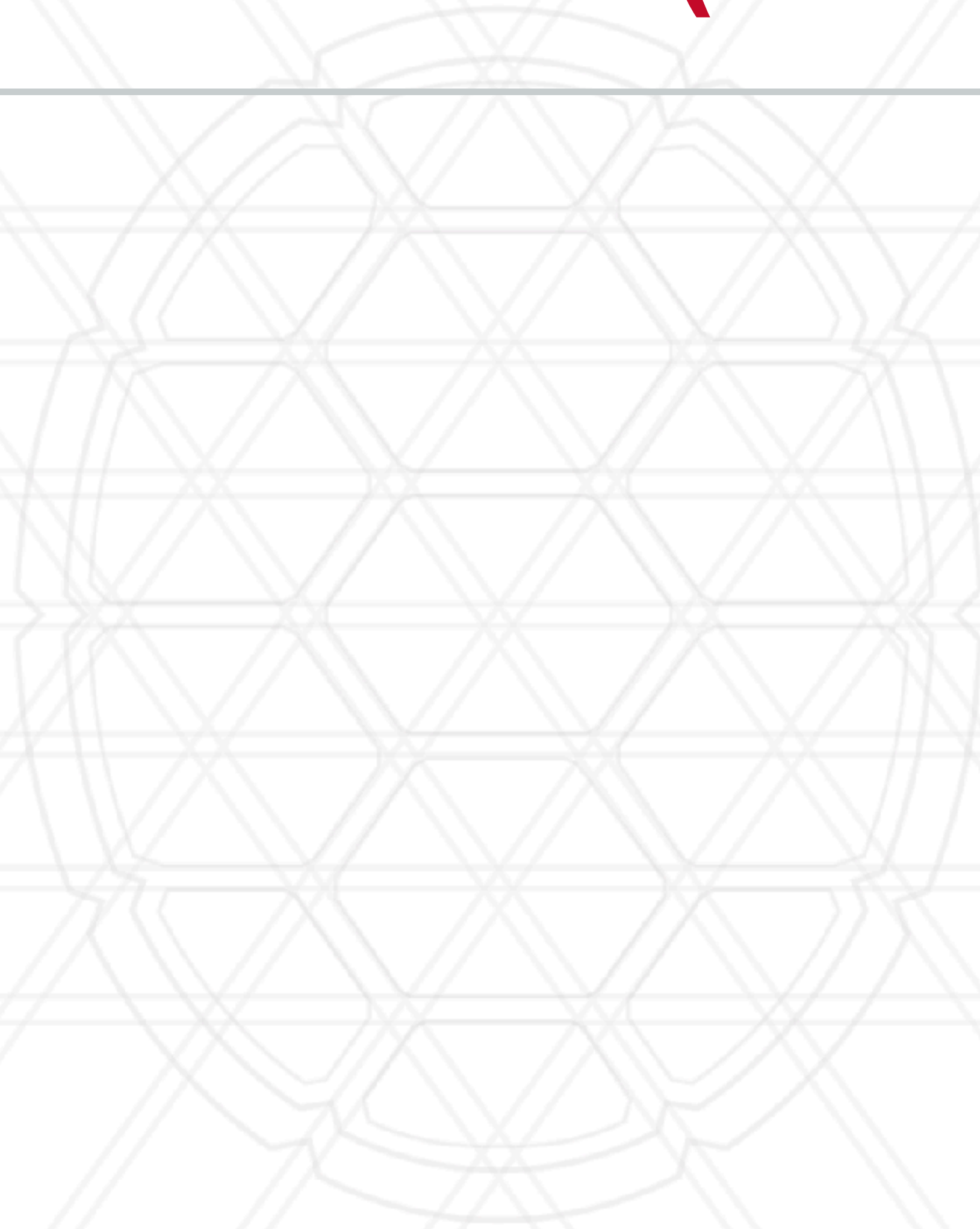

Parallelization of PME (3D FFT)

- Bring all the data to one process

Parallelization of PME (3D FFT)

- Bring all the data to one process
- 1D or slab decomposition

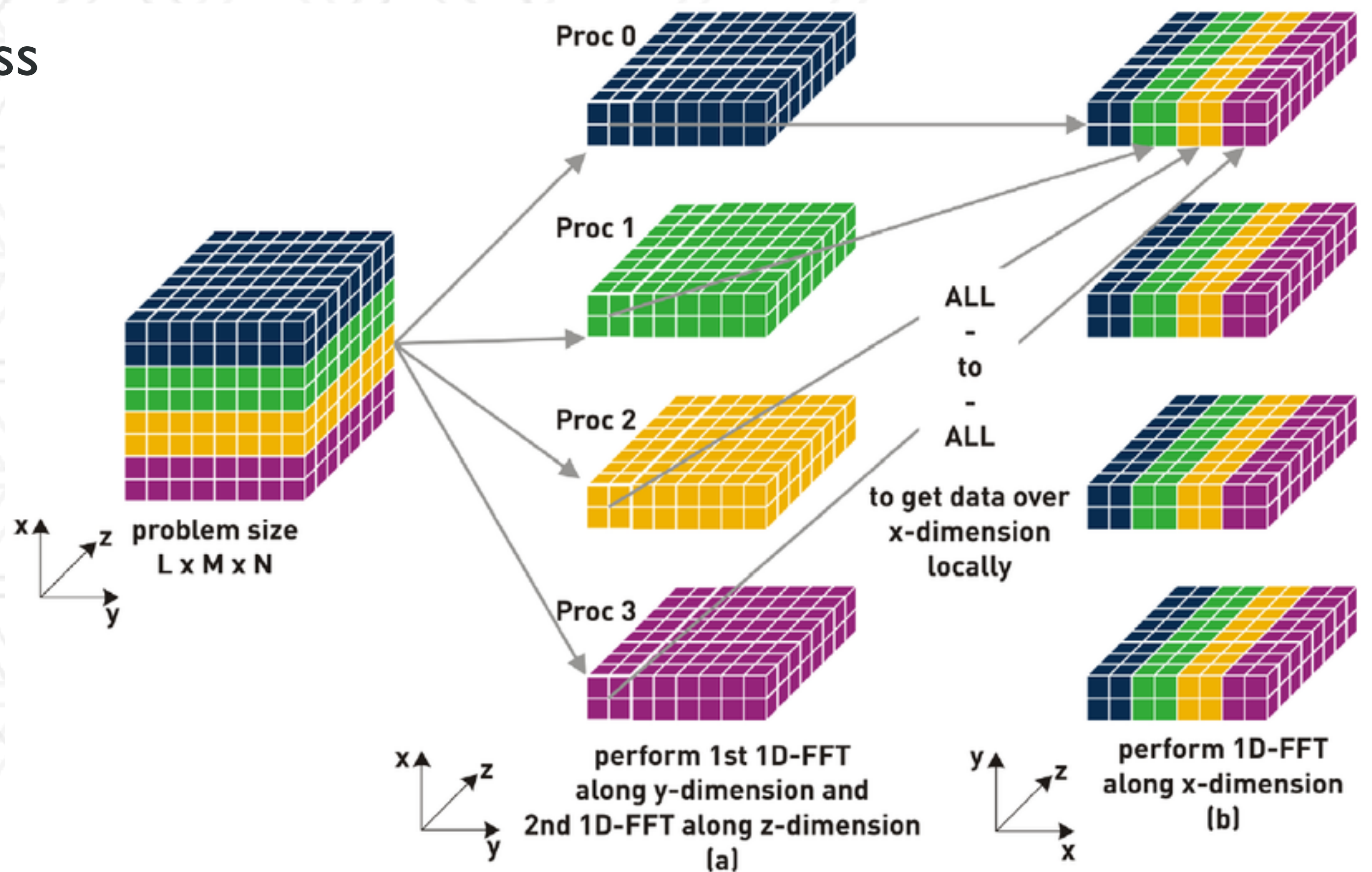

Parallelization of PME (3D FFT)

- 2D or pencil decomposition

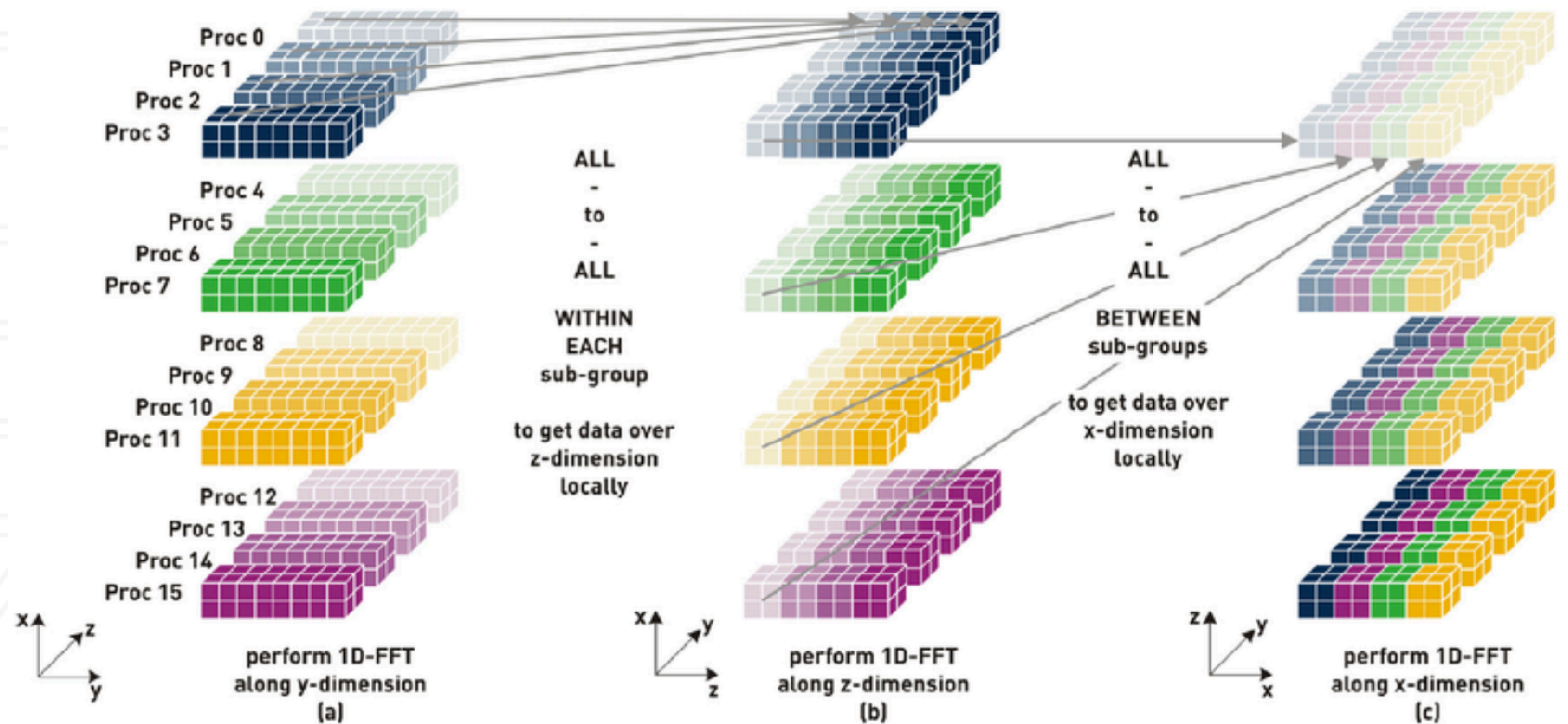

Measles killed 200,000 in 2020 alone!

LARGE MEASLES OUTBREAKS

The epidemic in the Democratic Republic of the Congo is the largest single-nation outbreak for decades.

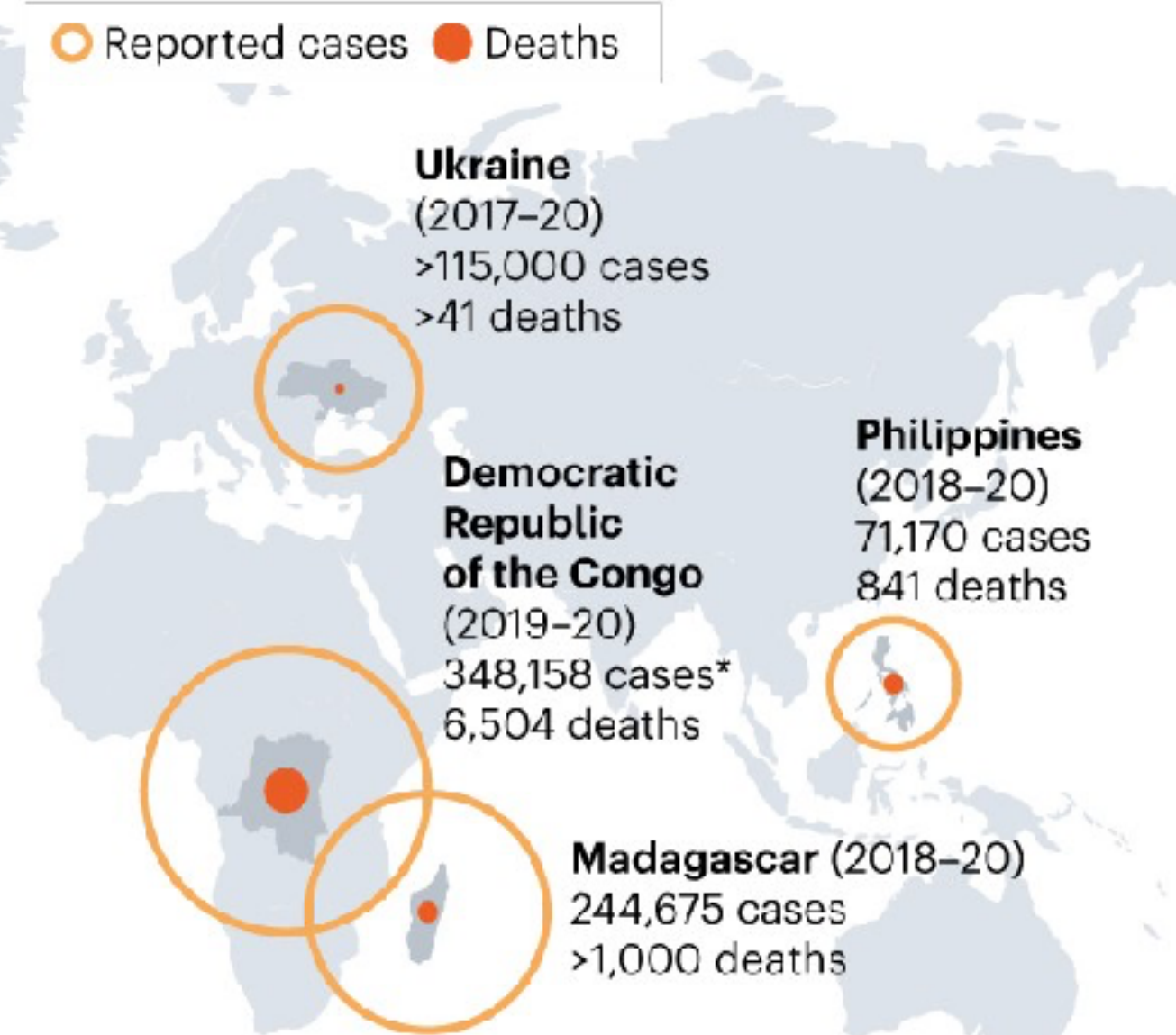

Data from March 2020.
*Suspected, not yet officially reported to WHO.

©nature

Global trends in the estimated number of deaths caused by TB and AIDS, 2000–2018

Shaded areas represent uncertainty intervals

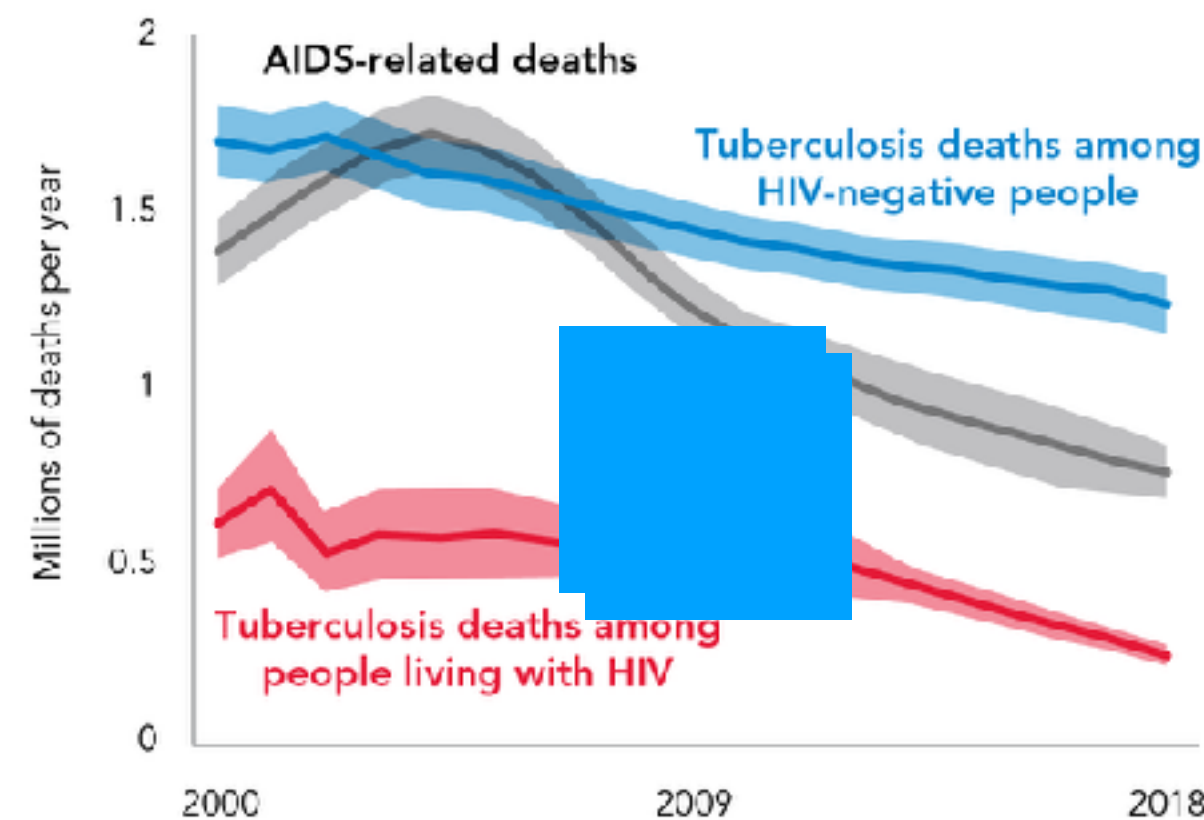

For AIDS, the latest estimates of the number of deaths in 2018 that have been published by UNAIDS are available at <http://www.unaids.org/en/>. For TB, the estimates for 2018 are those published in the Global Tuberculosis Report 2019. Deaths from TB among people living with HIV are officially classified as deaths caused by HIV/AIDS in the International Classification of Diseases.

Source: Global tuberculosis report 2019. Geneva: World Health Organization, 2019.

Predictions say that 1.66 million died of tuberculosis in 2020

TERRIBLE TOLL

By the end of July 2020, there had been 646,949 COVID-19 deaths worldwide. In the 32 countries and 4 major cities with relevant data, there were more excess deaths than COVID-19 deaths, suggesting that some COVID-19 deaths are misclassified or that other causes of death have also risen.

■ Deaths attributed to COVID-19 ■ Excess deaths

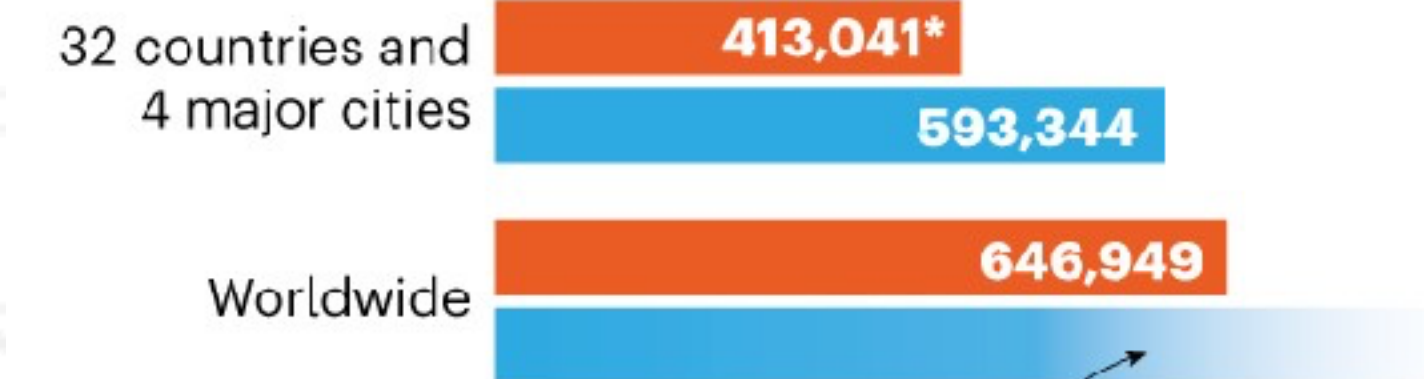

In August 2003, a heatwave in Europe caused 44,878 excess deaths

The global total of excess deaths is probably much higher than the number of COVID-19 deaths.

*Cumulative deaths from outbreak onset to latest available data, as of 18 August 2020.

©nature

<https://www.nature.com/articles/d41586-020-01011-6>

<https://www.nature.com/articles/d41586-020-02497-w>

Measles killed 200,000 in 2020 alone!

LARGE MEASLES OUTBREAKS

The epidemic in the Democratic Republic of the Congo is the largest single-nation outbreak for decades.

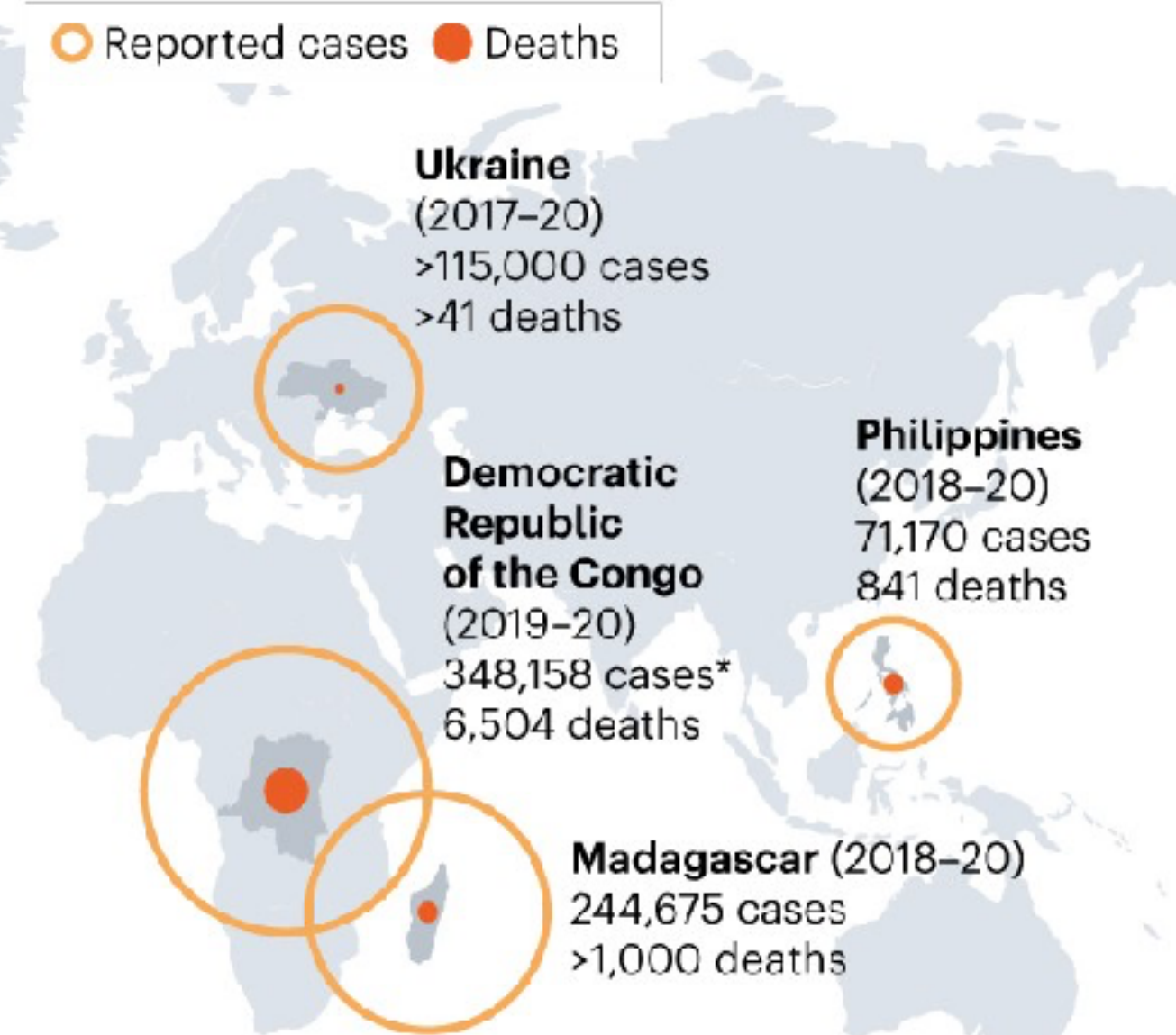

Data from March 2020.
*Suspected, not yet officially reported to WHO.

©nature

Global trends in the estimated number of deaths caused by TB and AIDS, 2000–2018

Shaded areas represent uncertainty intervals

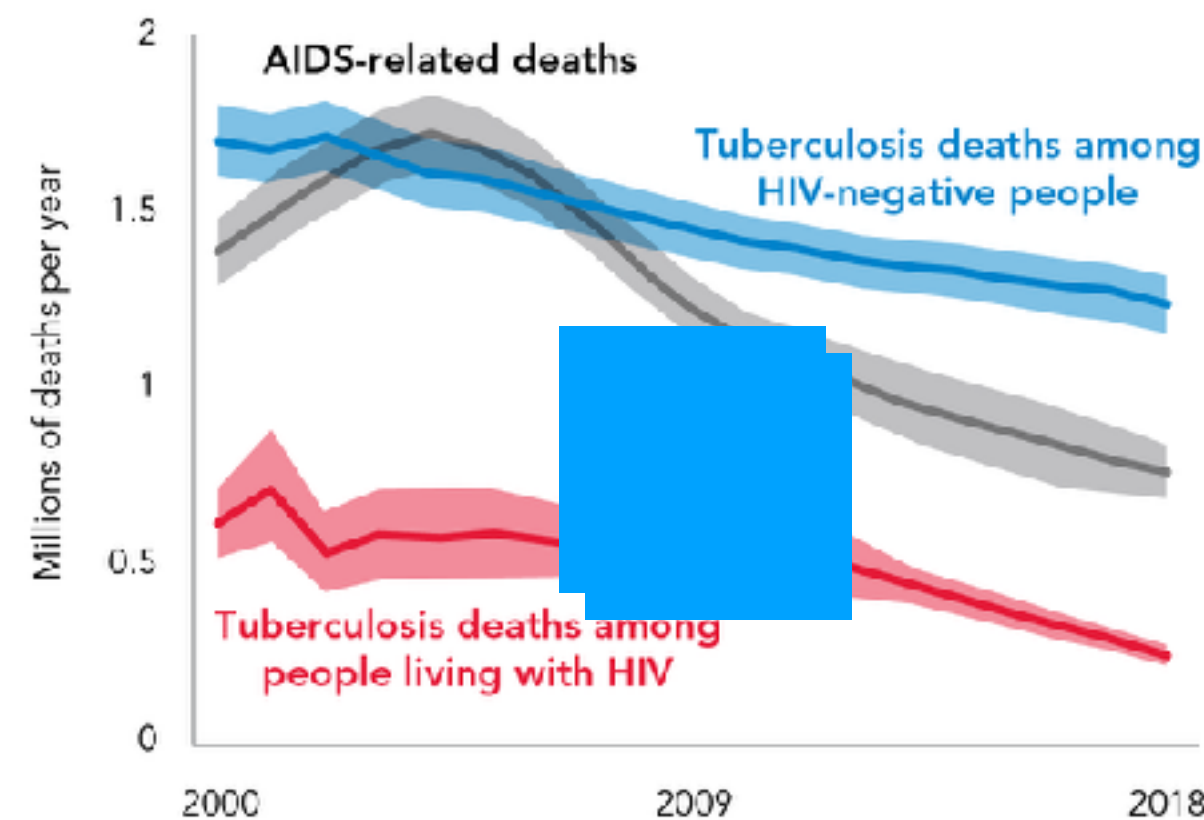

For AIDS, the latest estimates of the number of deaths in 2018 that have been published by UNAIDS are available at <http://www.unaids.org/en/>. For TB, the estimates for 2018 are those published in the Global Tuberculosis Report 2019. Deaths from TB among people living with HIV are officially classified as deaths caused by HIV/AIDS in the International Classification of Diseases.

Source: Global tuberculosis report 2019. Geneva: World Health Organization, 2019.

Predictions say that 1.66 million died of tuberculosis in 2020

TERRIBLE TOLL

By the end of July 2020, there had been 646,949 COVID-19 deaths worldwide. In the 32 countries and 4 major cities with relevant data, there were more excess deaths than COVID-19 deaths, suggesting that some COVID-19 deaths are misclassified or that other causes of death have also risen.

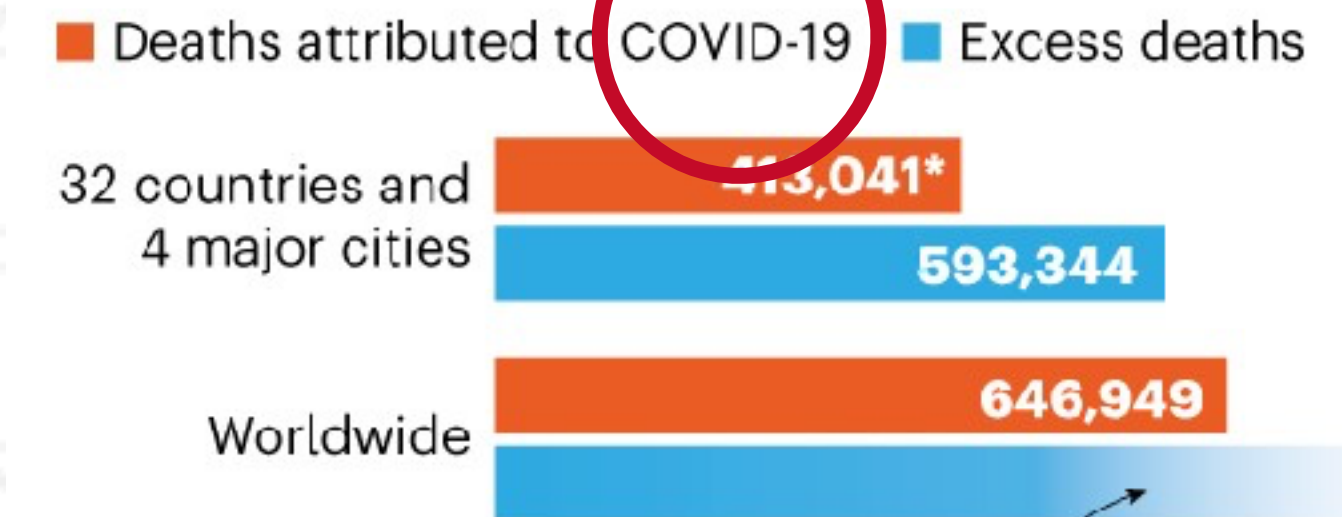

In August 2003, a heatwave in Europe caused 44,878 excess deaths

The global total of excess deaths is probably much higher than the number of COVID-19 deaths.

*Cumulative deaths from outbreak onset to latest available data, as of 18 August 2020.

©nature

<https://www.nature.com/articles/d41586-020-01011-6>

<https://www.nature.com/articles/d41586-020-02497-w>

Societal challenge

- Controlling the spread of infectious diseases is important
- Computational and mathematical modeling of epidemics important to assist governments in responding to outbreaks
- Made challenging due to:
 - increased and denser urbanization
 - increased local and global travel
 - increasingly immuno-comprised population

Approach: individual-based simulation

- Agent-based modeling to simulate epidemic diffusion
- Models agents (people) and interactions between them
- People interact when they visit the same location at the same time
- These “interactions” between pairs of people are represented as “visits” to locations
- Use a bi-partite graph of people and locations or a people-people interactivity graph

Serial algorithm

- At each timestep (typically a day):
 - Determine which people visit which locations
 - “Send” people to those locations
 - At each location “interactions” happen and transmission happens
 - Update people’s states at the end of the day and continue
- Interventions (vaccinations, school closures) can be added on certain days to change people’s susceptibility, movements etc.

Combination of network theory and discrete-event simulations

- Hybrid time-stepped and discrete-event simulation

Combination of network theory and discrete-event simulations

- Hybrid time-stepped and discrete-event simulation

Contact model at each location



Combination of network theory and discrete-event simulations

- Hybrid time-stepped and discrete-event simulation

Contact model at each location



Model for human transmission

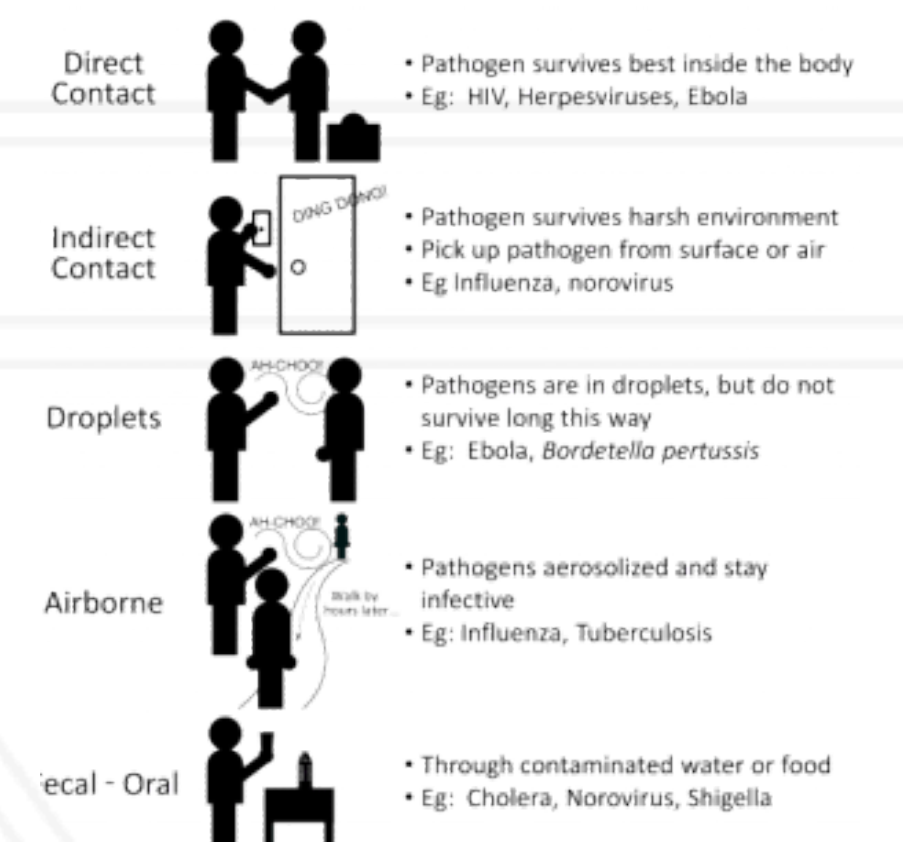

Combination of network theory and discrete-event simulations

- Hybrid time-stepped and discrete-event simulation

Contact model at each location



Model for human transmission

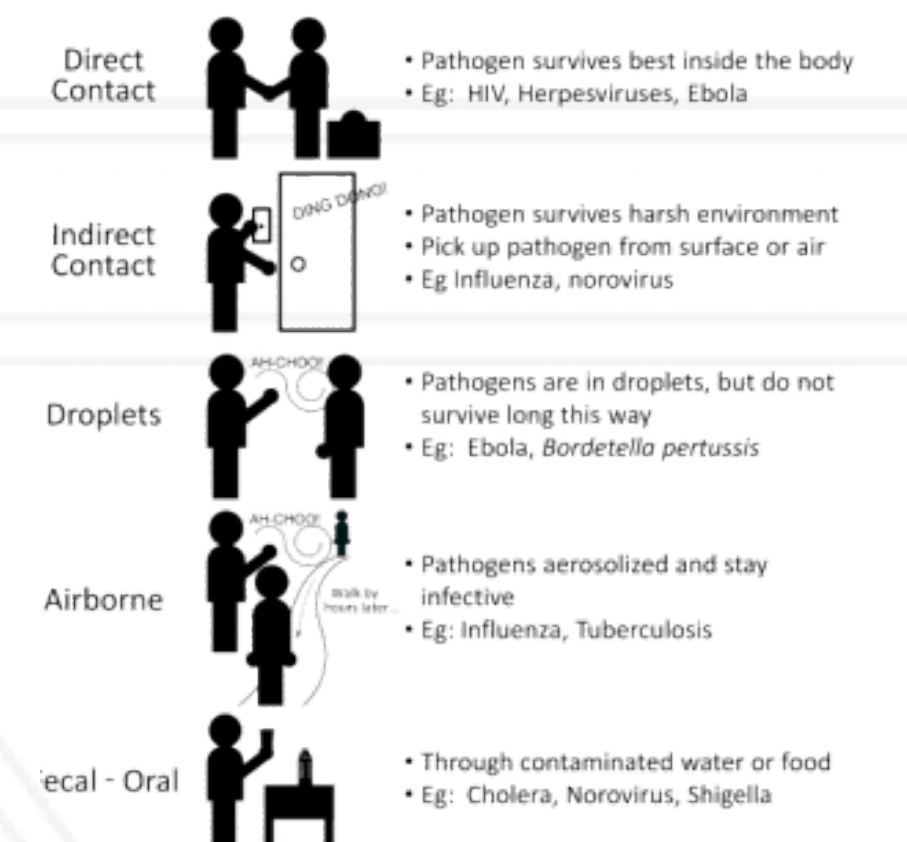

Disease model for each person

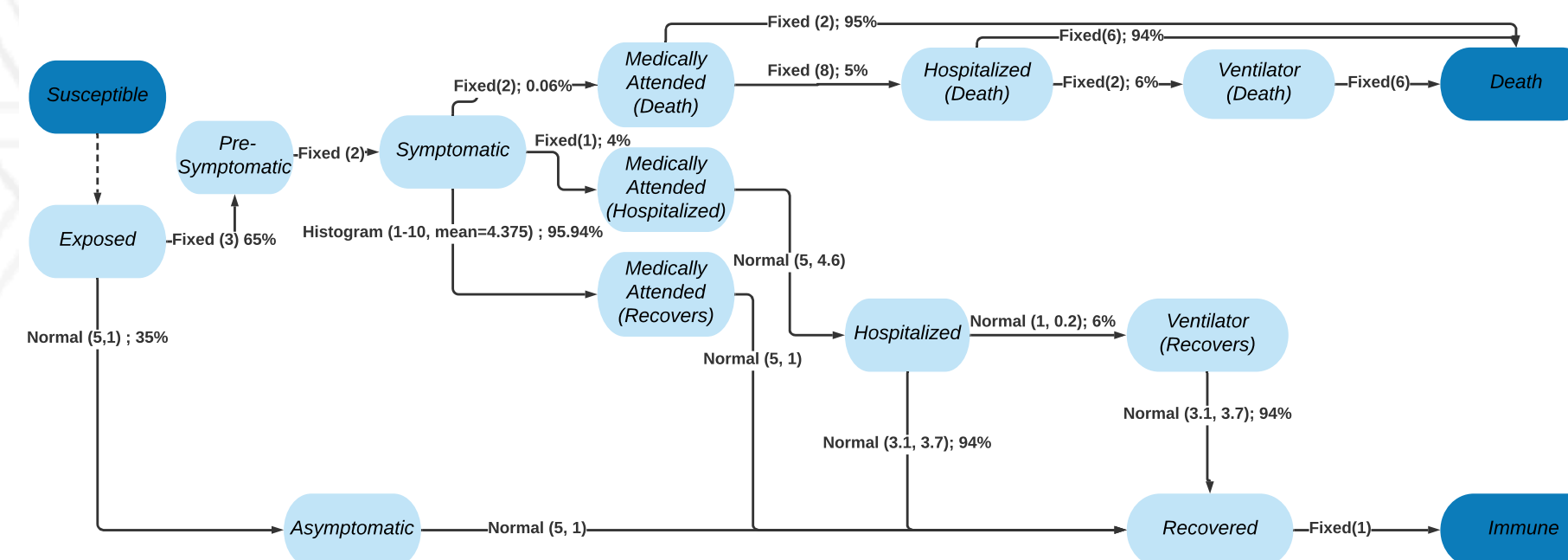

<https://sitn.hms.harvard.edu/flash/special-edition-on-infectious-disease/2014/an-introduction-to-infectious-disease/>

Combination of network theory and discrete-event simulations

- Hybrid time-stepped and discrete-event simulation

```
while d < num_days:
  for each person:
    Send visit messages to locations
```

```
for each location:
  Process all visit messages
  Run discrete event simulation
  Send interaction messages
```

```
for each person:
  Process interactions
  Update disease state
```

Contact model at each location



Model for human transmission

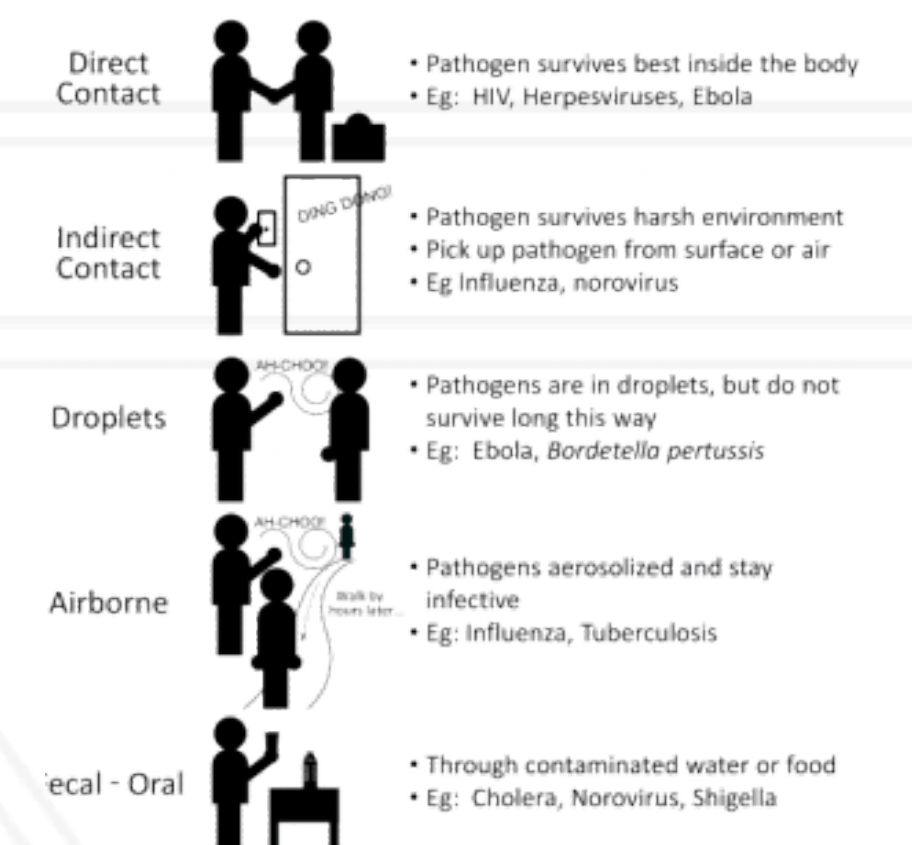

Disease model for each person

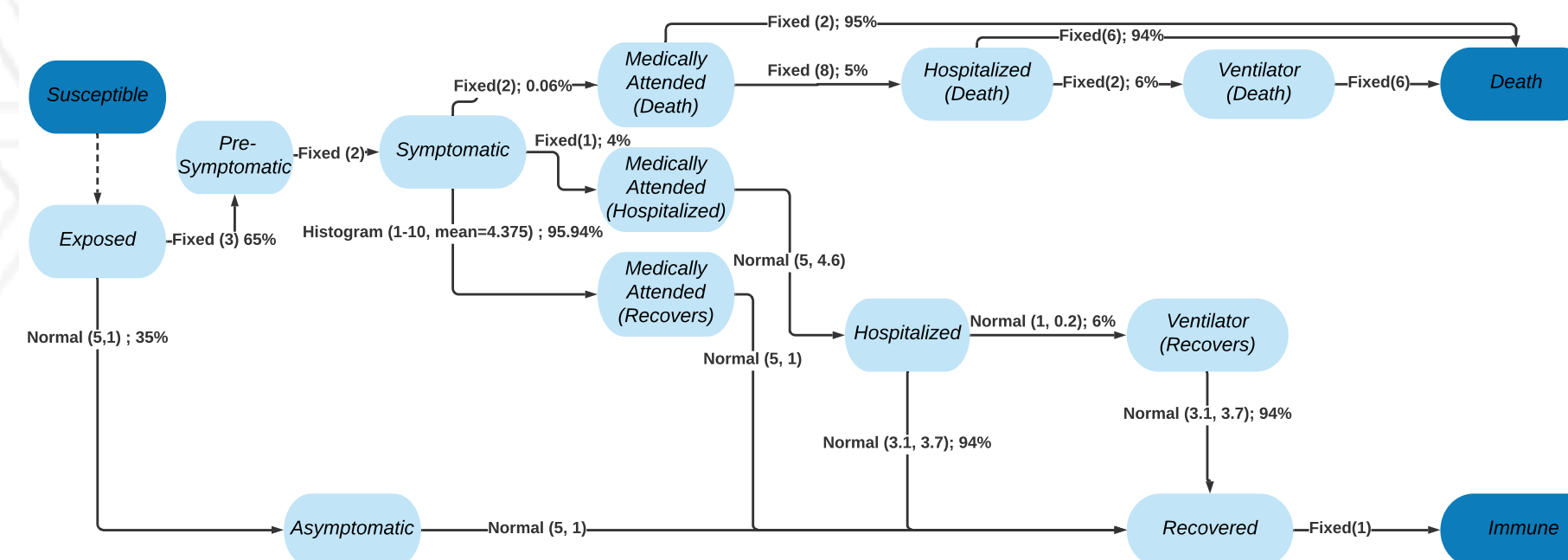

Parallel simulation is challenging

- Size and scale of the social contact network (6 billion agents for a global simulation)
 - Unstructured networks and complicated dependencies lead to high communication cost
- Individuals and their behaviors are not identical
- Co-evolving epidemics, public policies and agent behaviors make it impossible to apply standard model reduction techniques

Parallel implementation: Loimos

- All the people and locations are distributed among all processes
- DES computation can be done locally in parallel
- Communication when sending visit and infection messages
- Uses Charm++, a message-driven model

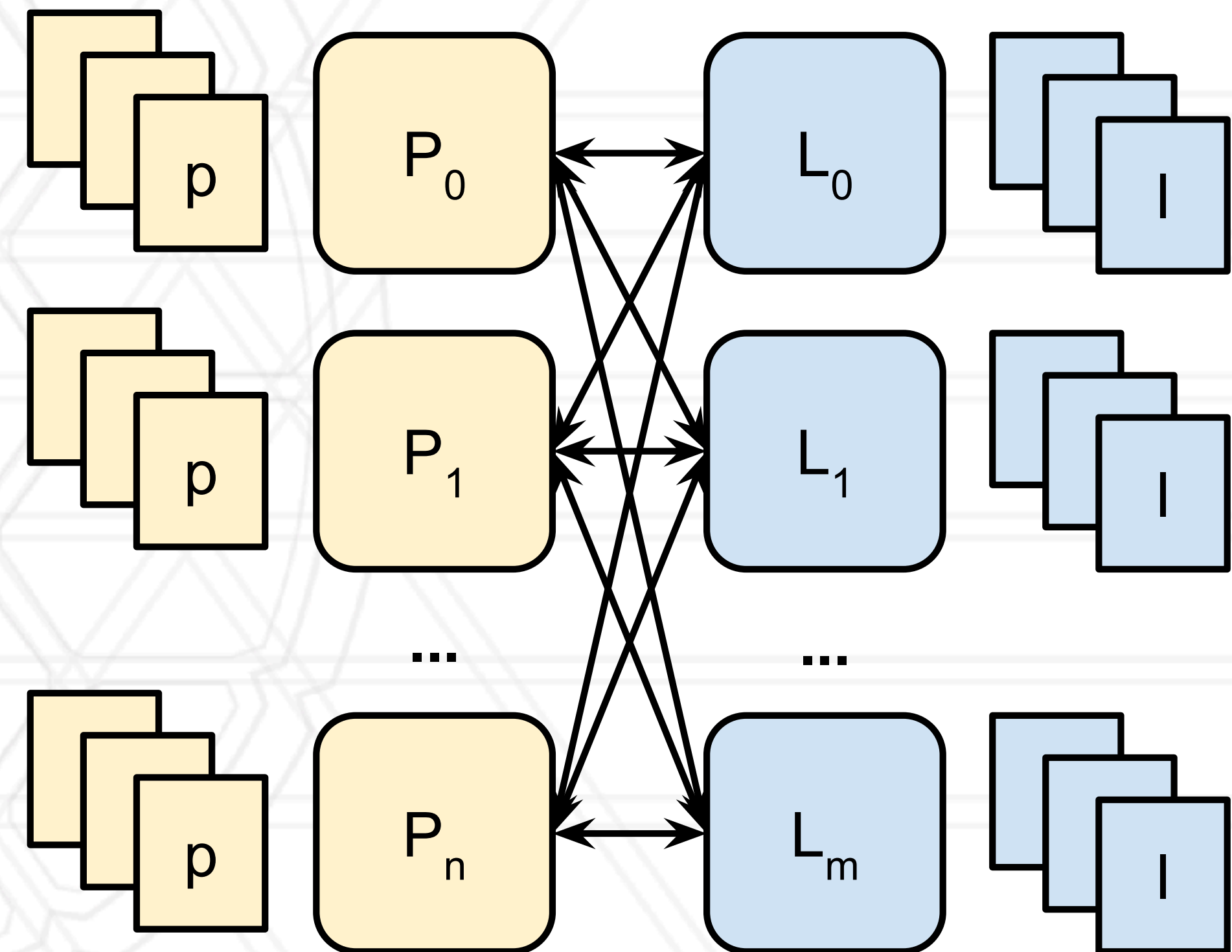

Application software stack

- Parallel programming model / runtime:

- MPI, OpenMP, Charm++, CUDA, ...

- Libraries

- Data and visualization libraries (mesh management, simulation output)
- I/O libraries
- Math/numerical libraries
- Graph partitioning, load balancing ...

User program

Libraries

Parallel prog. runtime (MPI, Charm++ etc.)

Why use libraries?

- No need to reinvent the wheel
- Significant effort to write and optimize code

Popular Libraries

- Data/visualization and I/O libraries
 - I/O: HDF5, pNetCDF, Adios
- Numerical libraries:
 - Fast Fourier transforms: FFTW
 - Dense linear algebra: BLAS, LAPACK, Intel MKL
 - Solvers for sparse systems: Hypre, PETSc, Trilinos
- Graph partitioning/load balancing:
 - METIS, Scotch, Zoltan, Chaco

https://events.prace-ri.eu/event/176/contributions/38/attachments/154/305/HPC_libraries.pdf

Domain-specific languages/frameworks

- Structured grids: SAMRAI, Chombo, AMREx
- Unstructured grids: MFEM, Quinoa

The n -body problem

- Simulate the motion of celestial objects interacting with one another due to gravitational forces
- Naive algorithm: $O(n^2)$
 - Every body calculates forces pair-wise with every other body (particle)

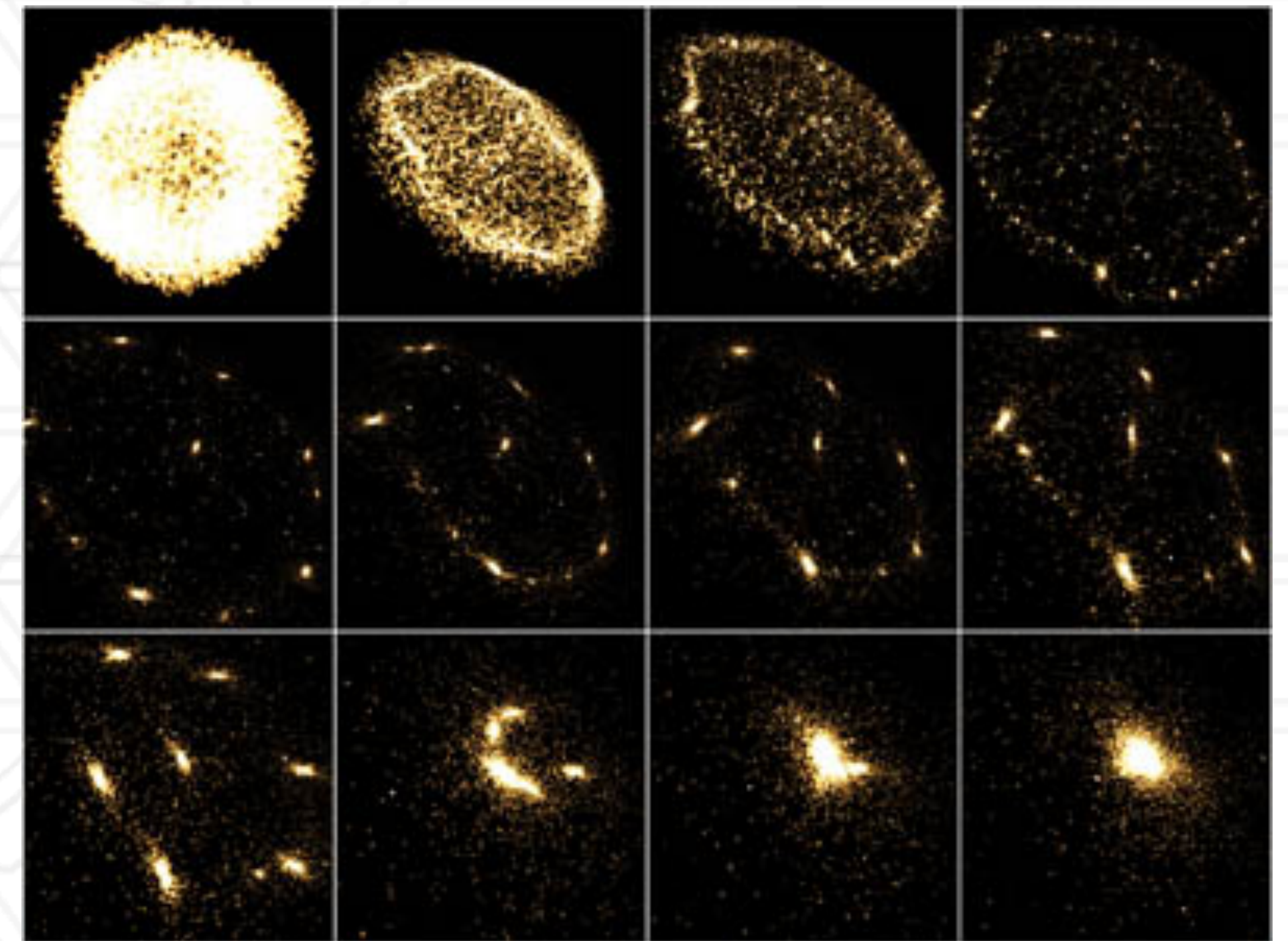

<https://developer.nvidia.com/gpugems/gpugems3/part-v-physics-simulation/chapter-31-fast-n-body-simulation-cuda>

Data distribution in n -body problems

- Naive approach: Assign n/k particles to each process
- Other approaches?

Data distribution in n -body problems

- Naive approach: Assign n/k particles to each process
- Other approaches?

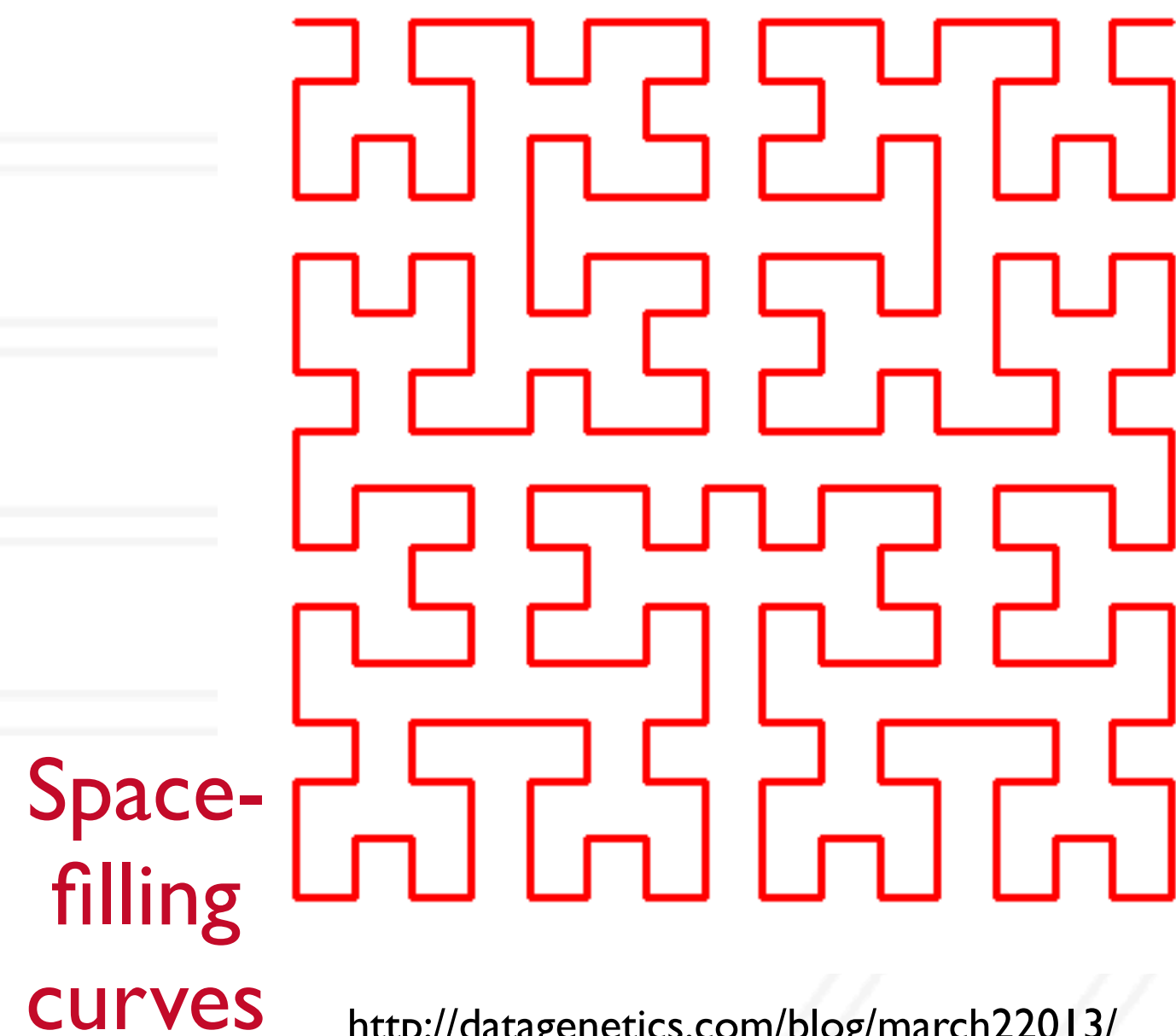

<http://datagenetics.com/blog/march22013/>
https://en.wikipedia.org/wiki/Z-order_curve

Data distribution in n -body problems

- Naive approach: Assign n/k particles to each process
- Other approaches?

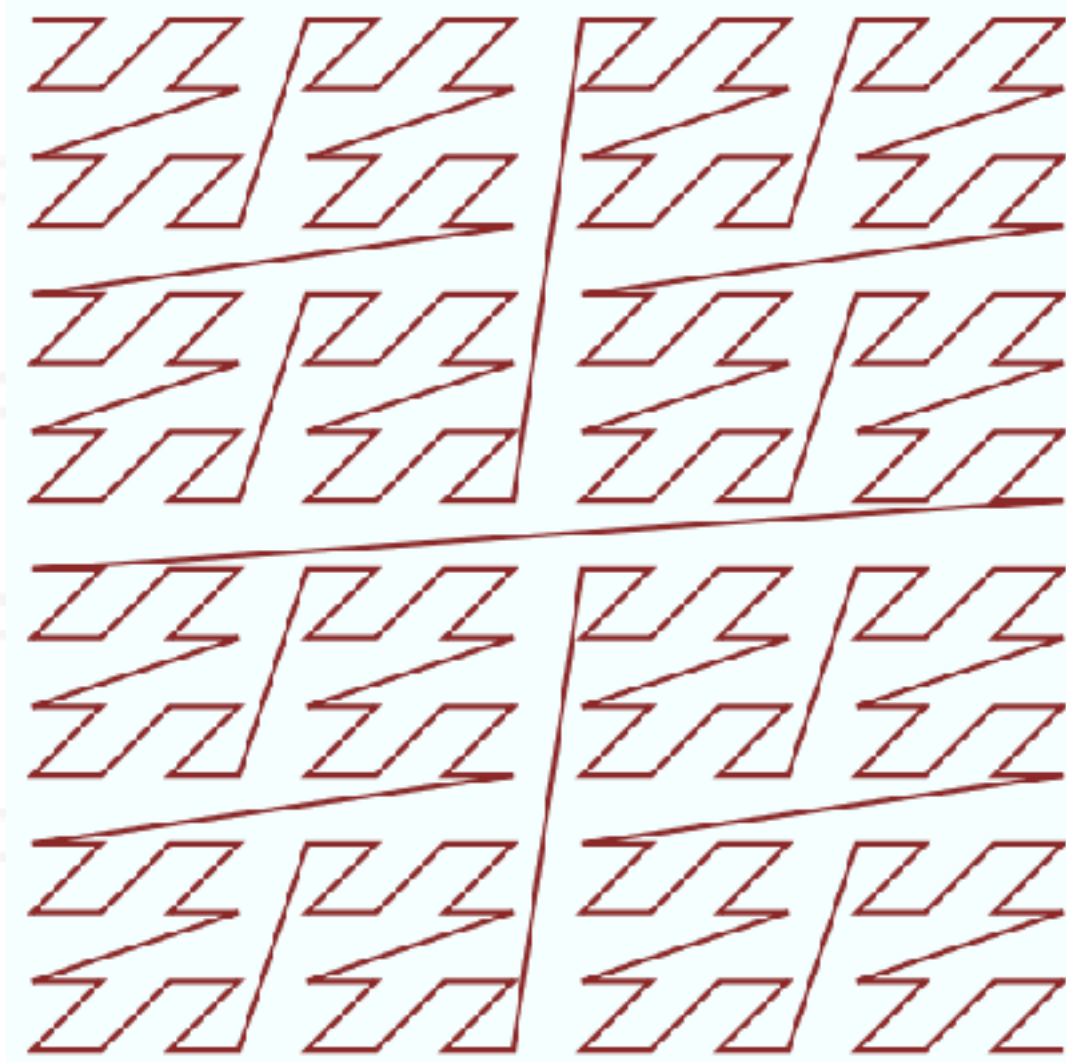

Space-
filling
curves

<http://datagenetics.com/blog/march22013/>

https://en.wikipedia.org/wiki/Z-order_curve

Data distribution in n -body problems

- Naive approach: Assign n/k particles to each process
- Other approaches?

Space-filling curves

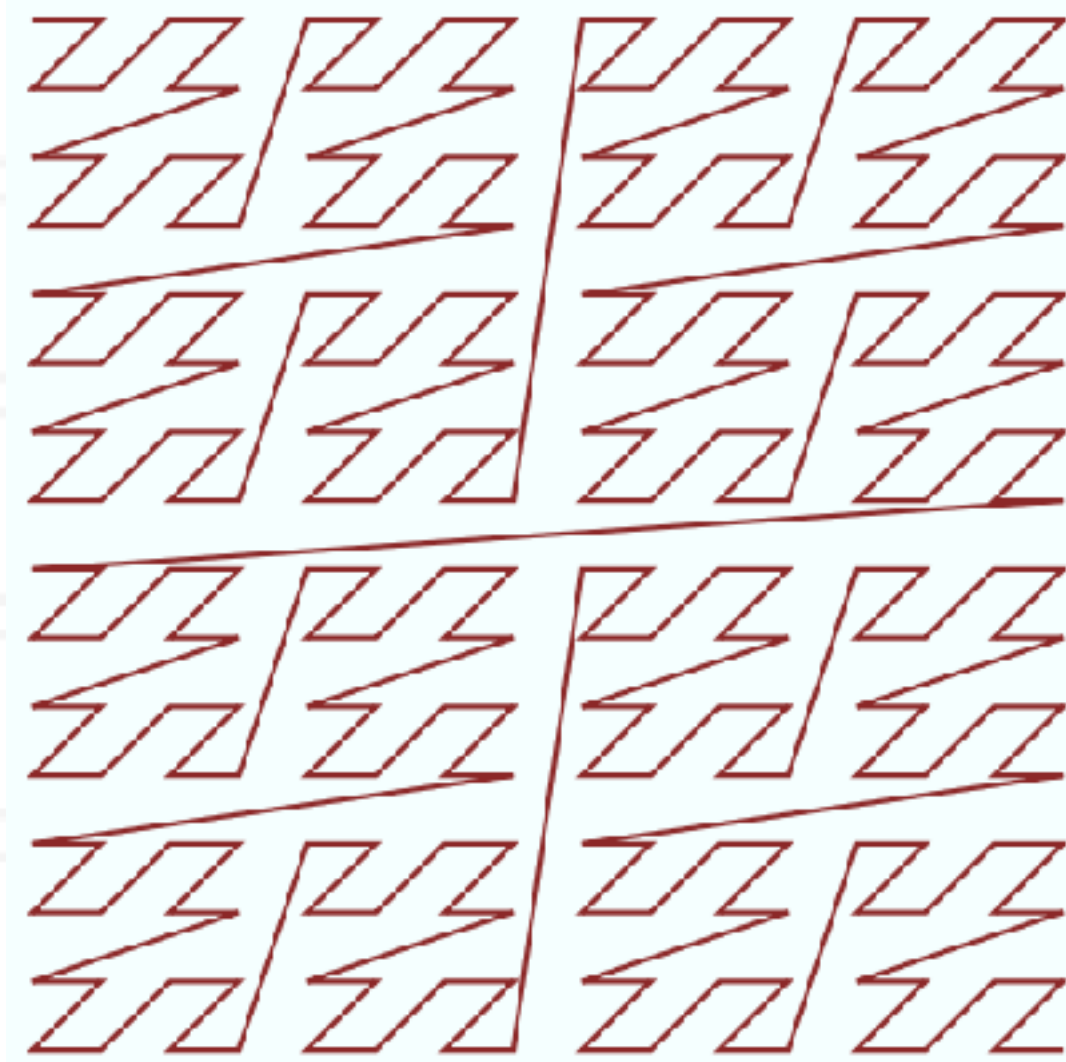

<http://datagenetics.com/blog/march22013/>
https://en.wikipedia.org/wiki/Z-order_curve

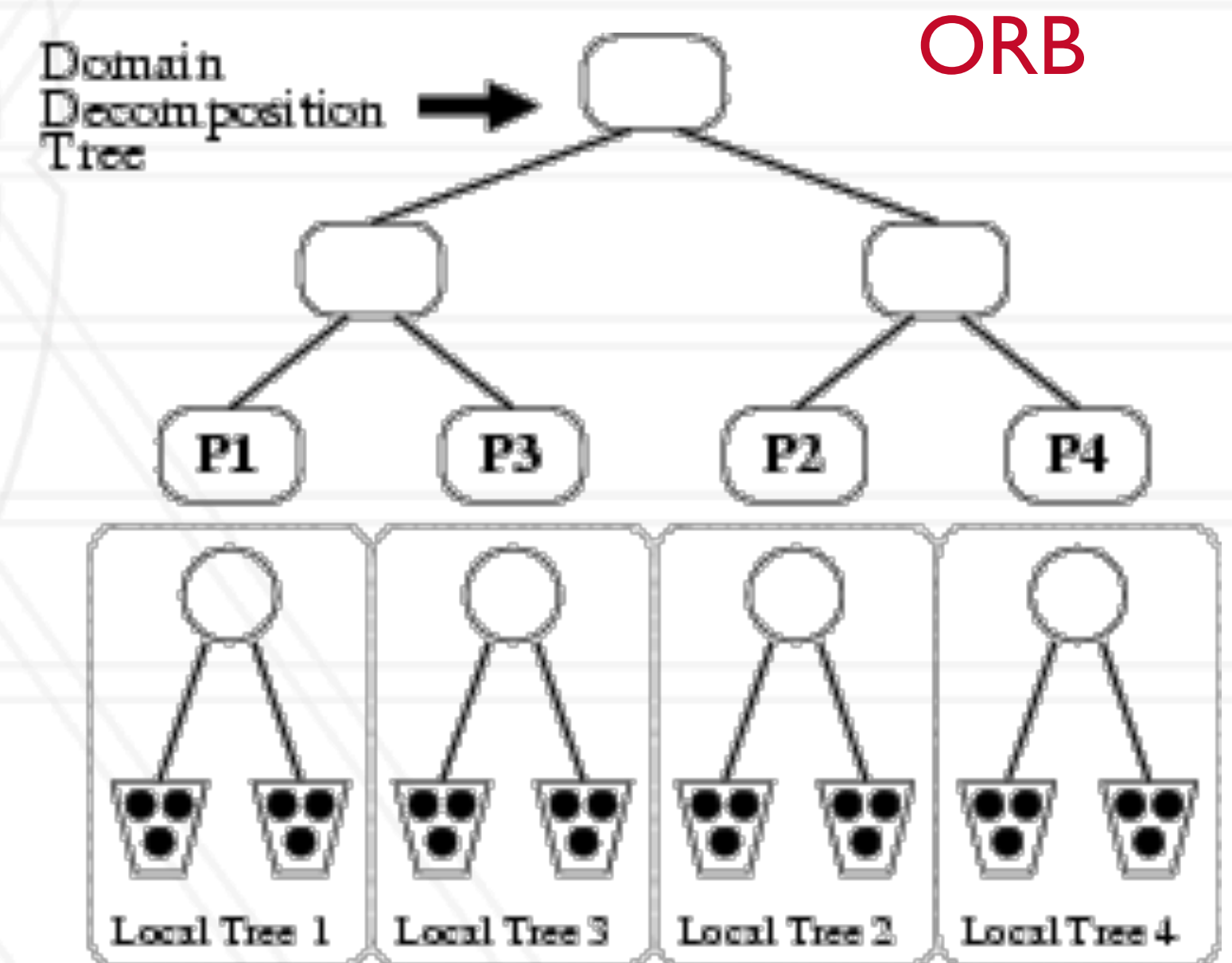
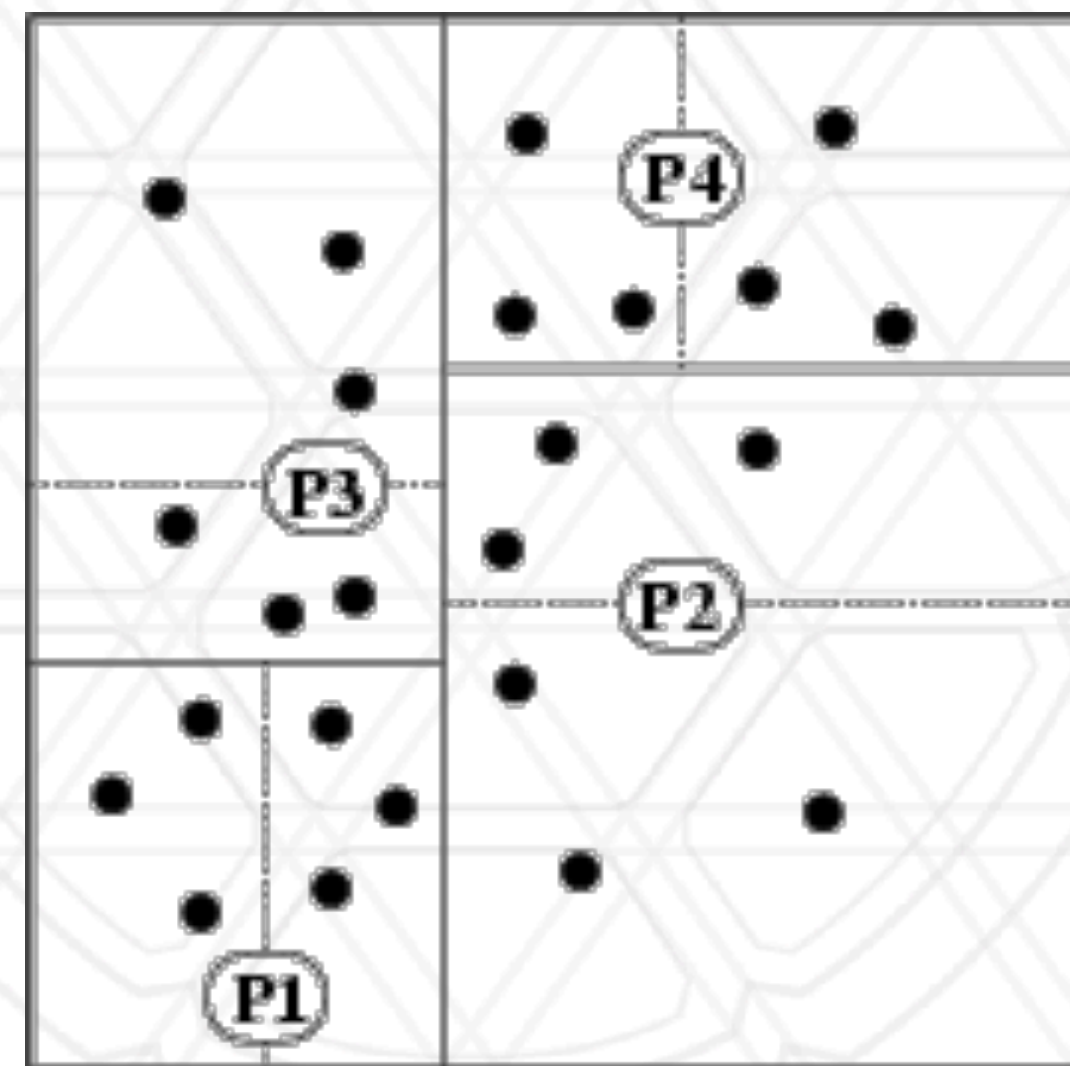

http://charm.cs.uiuc.edu/workshops/charmWorkshop2011/slides/CharmWorkshop2011_apps_ChANGa.pdf

Data distribution in n -body problems

- Let us consider a two-dimensional space with bodies/particles in it

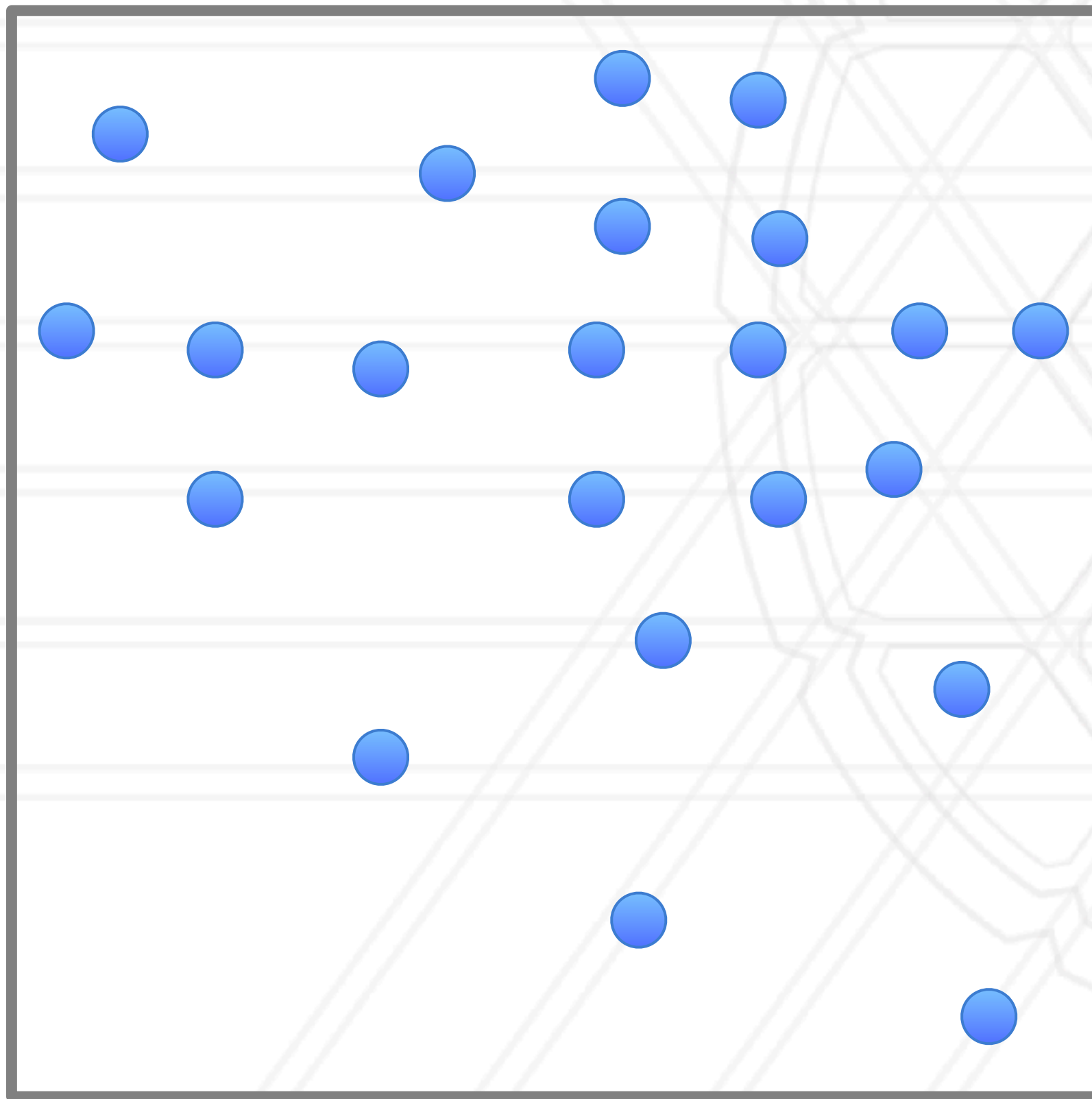

Data distribution in n -body problems

- Let us consider a two-dimensional space with bodies/particles in it

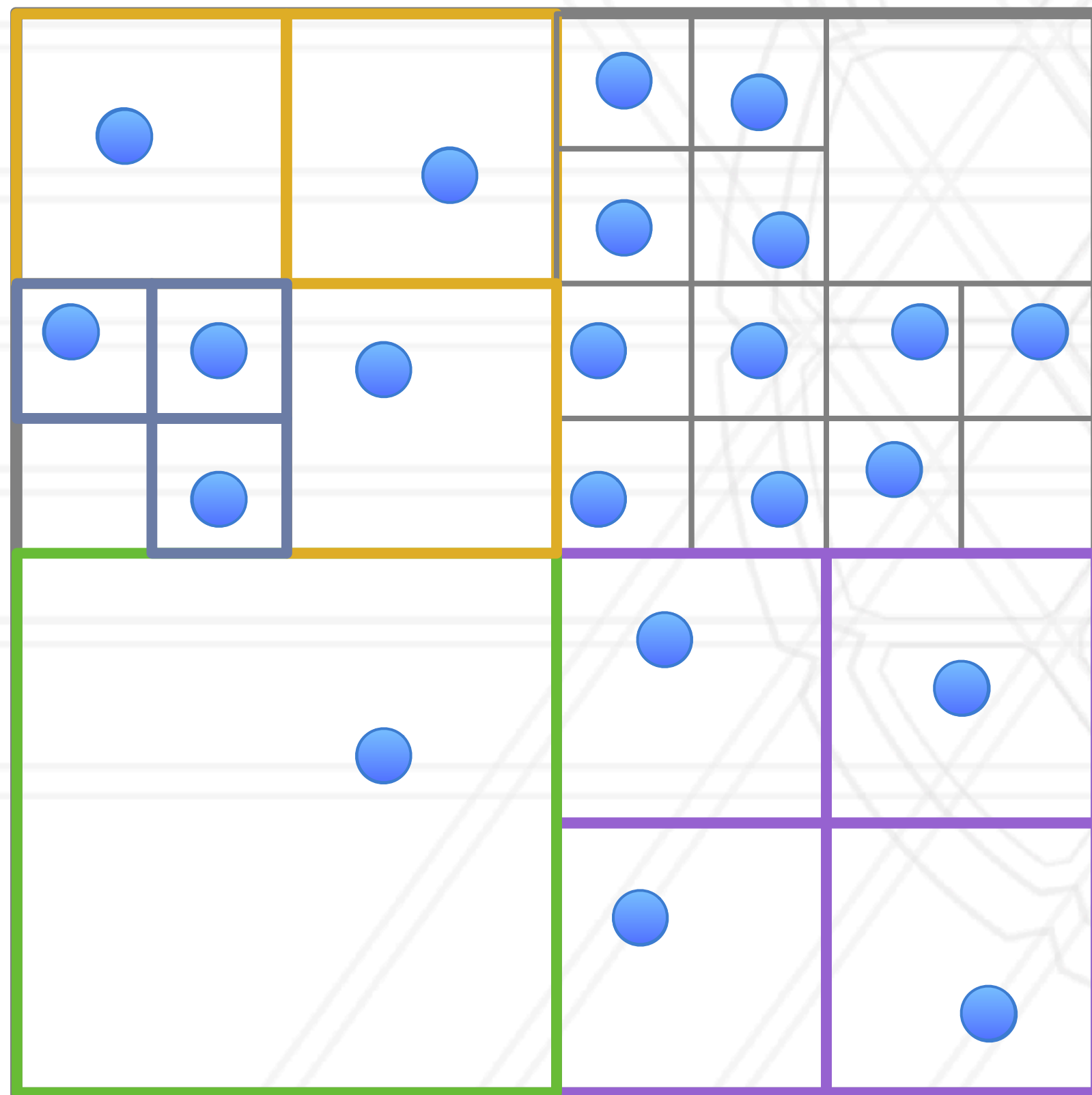

Data distribution in n -body problems

- Let us consider a two-dimensional space with bodies/particles in it

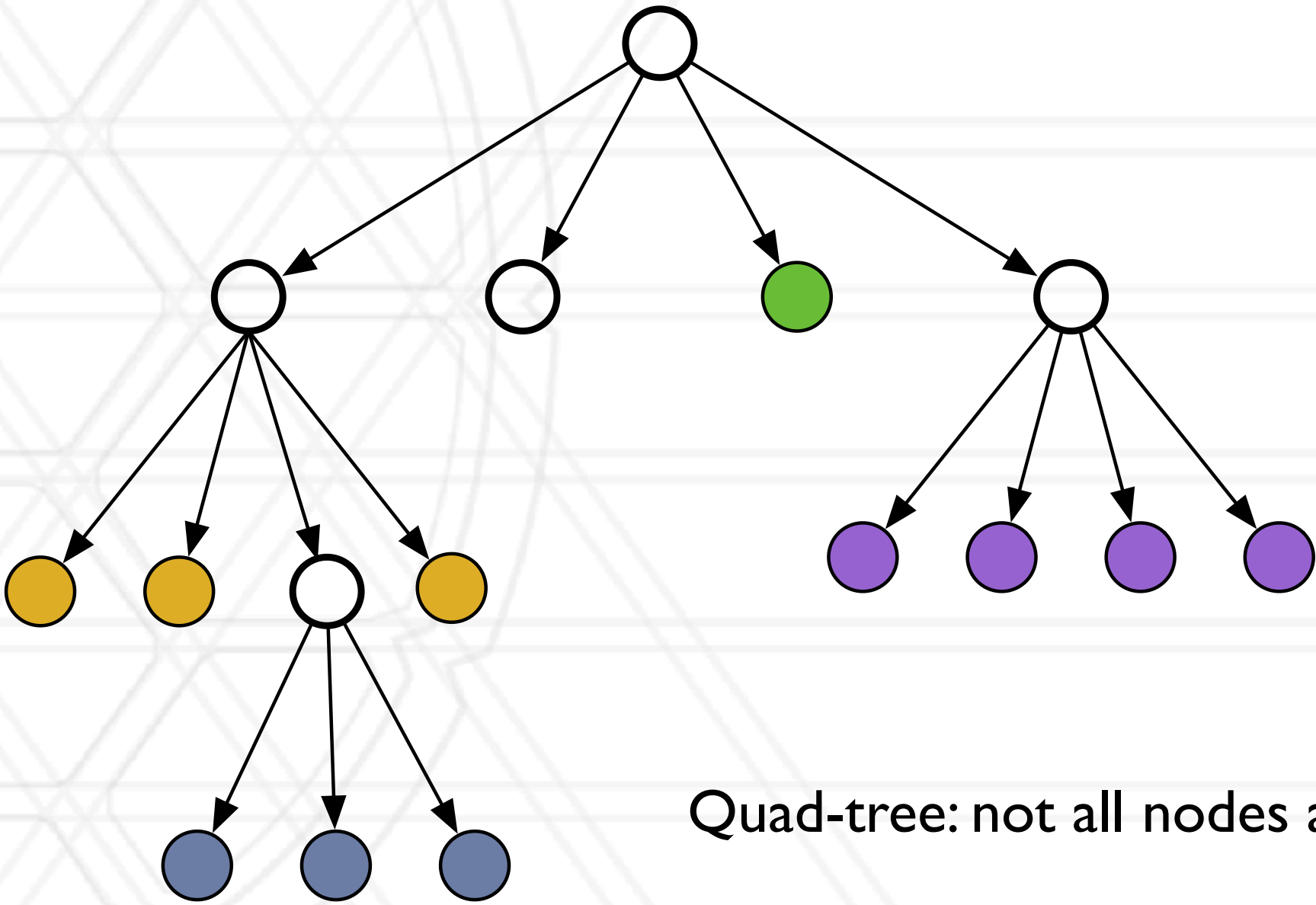
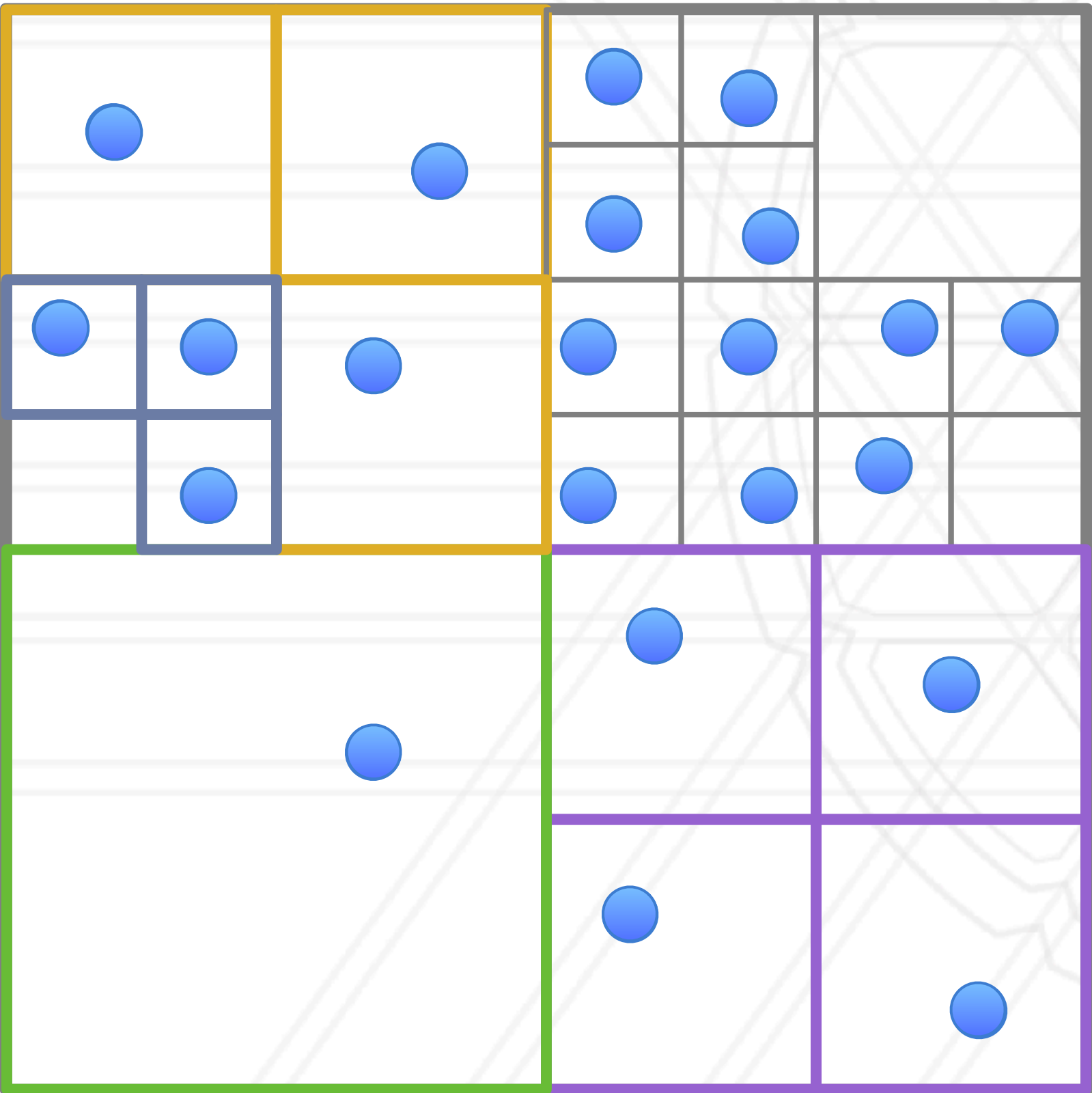

Different parallelization methods

- Tree codes: Barnes-Hut simulations
- Fast multipole methods (FMM): Greengard and Rokhlin
- Particle mesh methods
- Particle-particle particle-mesh (P³M) methods

Barnes-Hut simulation

- Represent the space containing the particles as an oct-tree
- Pairwise force calculations for nearby particles
- For tree nodes that are sufficiently far away, approximate the particles in the node by a single large particle at the center of mass

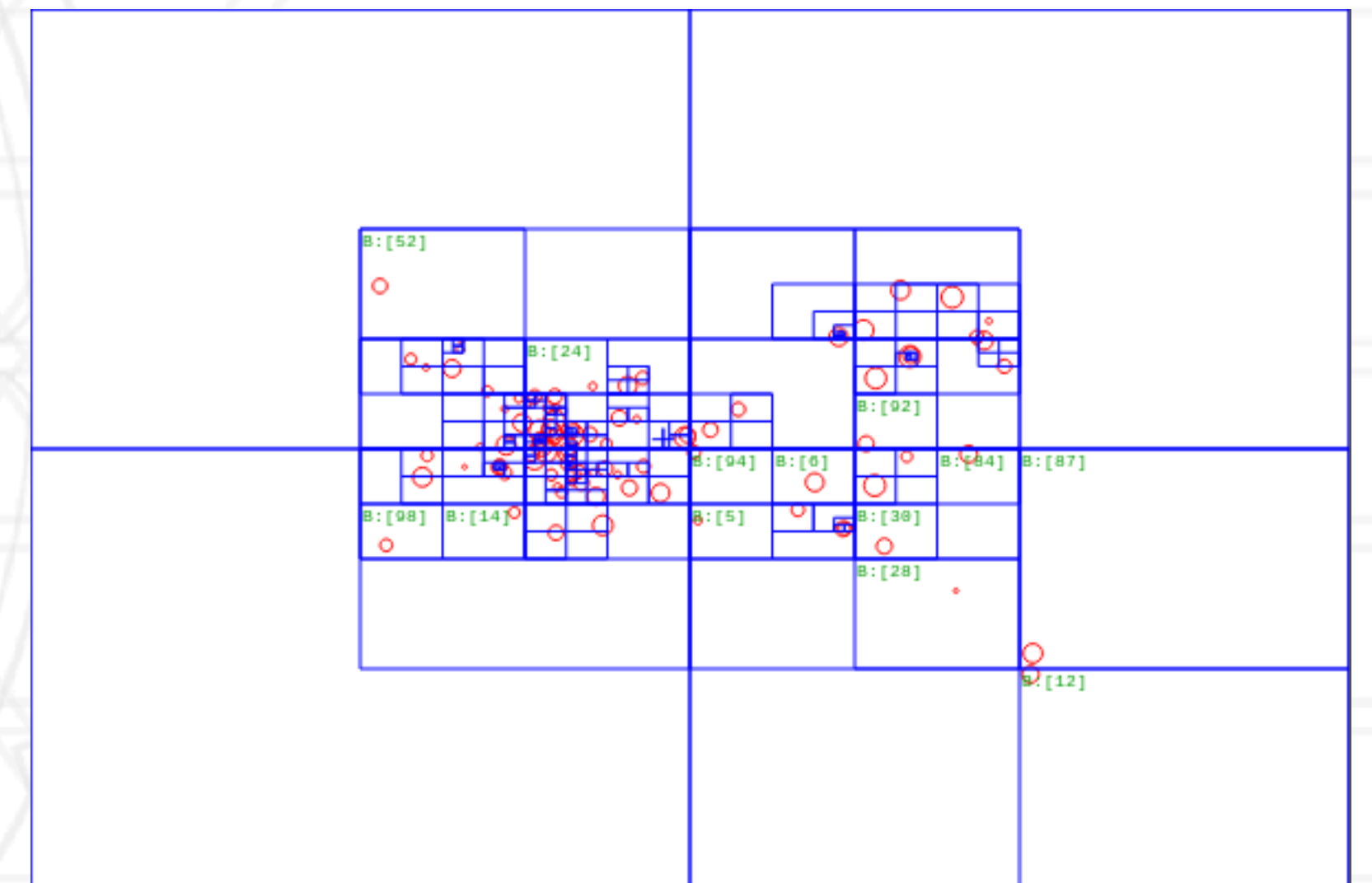

https://en.wikipedia.org/wiki/Barnes-Hut_simulation

Fast multipole methods

- Use multipole expansion for distant particles
- Takes advantage of the fact that for nearby particles, multipole-expanded forces from distant particles are similar
- Reduces the time complexity further to $O(n)$

Particle-particle particle-mesh methods

- Explicit calculation of forces on nearby particles
- Fourier-based Ewald summation for calculating potentials on a grid
- Smoothed particle hydrodynamics



UNIVERSITY OF
MARYLAND

Abhinav Bhatele

5218 Brendan Iribe Center (IRB) / College Park, MD 20742

phone: 301.405.4507 / e-mail: bhatele@cs.umd.edu